

## Advanced Manhattan Building

by Chuck Adams, K7QO

This article is intended to give you an advanced construction techniques for homebrewing and give more detail on Manhattan Style of construction. At the beginning of each section is a brief paragraph outlining the current topic. I will assume that you have already become familiar with my other article on this area of building.

### PC Board Material

Here is a photograph of prepared PC board material as outlined in my other article. This board has been cleaned and then coated with a very thin film of clear spray such as Krylon.



Prepared PC Board.

### Resistor Mounting

Let's first start with a simple resistor. In a circuit diagram you may see a resistor connected to two points in the following manner.

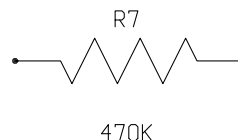

Resistor Schematic.

I have written a computer program to do my graphics for showing the layout of a circuit on the PC board. I did this to be able to generate diagrams, modify them for circuit changes that may occur, and be able to redraw them rapidly and include the graphics in articles both on and off the web. This is what the physical layout would be for the above resistor. I use circular mounting pads for my building projects and my diagrams will reflect that. If you prefer rectangular pads, then by all means use them to replace my circular ones.

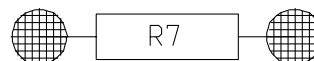

Pictorial Layout.

So in order to mount a resistor to the PC board you glue two pads and then solder the resistor

between the pads as shown in the next photograph. This using the technique written up in the previous Manhattan article.



Bend the leads of the resistor carefully to account for the height of the pads and then solder the resistor to the pad as shown in the following photograph.

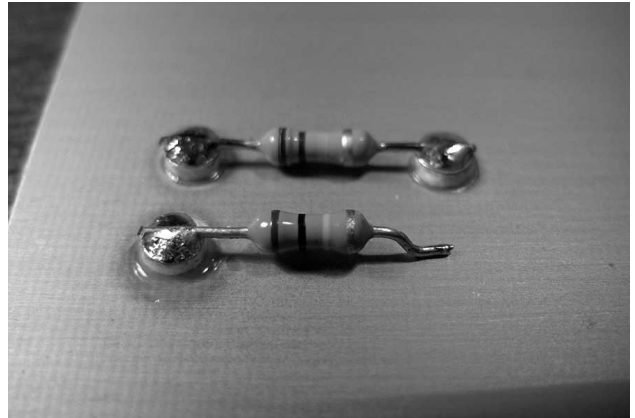

Another configuration is where one end of the resistor goes to ground. For Manhattan projects the ground plane is the PC board surface itself. The schematic would show something like the following.

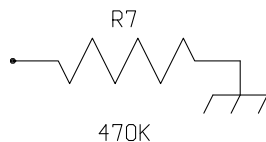

Now solder the ground lead to the ground plane. Even though there is a coat of clear paint on the board the heat from the soldering iron and solder will remove the coat and the connection will be made to the PC board. It may take you a little practice to get a neat looking connection but practice on some scrap material before starting on a large project. It is time and effort well spent. Here is how mine look.

The layout diagram would show the following.



Now if you really want to save real estate on a board you will have to learn to mount components like resistors and diodes vertically. The schematic diagram does not change but the layout does. Here is an example of a resistor mounted vertically and note the room that is saved on the board.

that sometimes the lower wire to the pad will not show up but you will know what to do. Here is two different ways it may appear in a more complicated layout design dependent upon space restrictions.

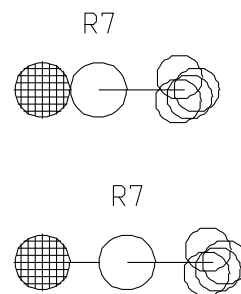
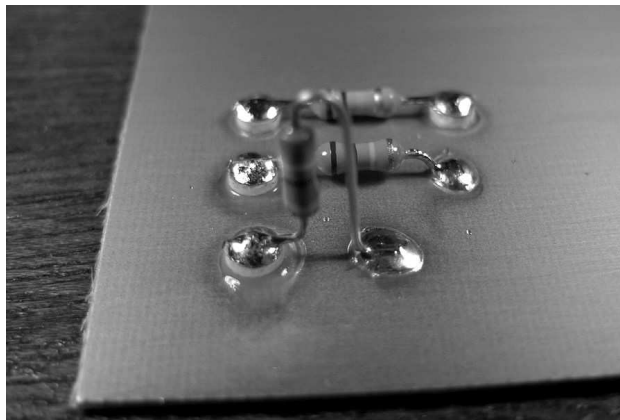

Here it is from a different angle. The digital camera has difficulty focusing on the vertical resistor but you get the idea.



This is the way the vertical resistor component will look in my graphics layout routine. Note

IF Transformer Mounting

For the IF transformer we need to make a rectangular or square pad that has nine areas. I do this using the same technique that I use for making IC pads, but instead of making the cross cuts at 0.10" centers I measure and mark at 3.5mm along the edge of the pad. This makes the pad about 1cm along the edge for the pads.

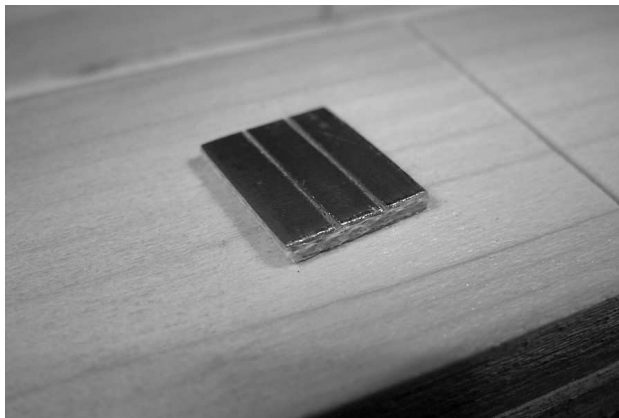
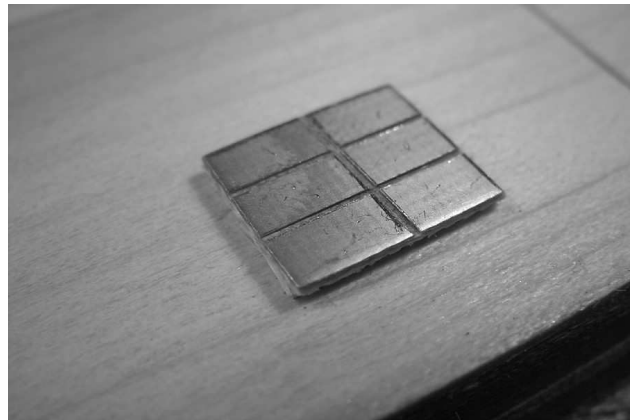

This pad now needs to be tinned. Since it is so small I take an ordinary wooden clothes pin and cut one of the ends diagonally as follows. This makes a nice miniature vise to hold the pad while tinning with solder. Again, afterwards make sure you check for shorts. I put just a small amount of solder to make the surface as level as possible so that when I solder the IF transformer to the pad it is level. Add a touch of solder afterwards to “wick” to the transformer pins and get a solid mechanical and electrical connection.

I then make a cut down the middle at right angles to the 3 sections of the pad. This cut doesn't have to be exact. Afterwards I make sure that I take a DVM with a continuity checker with sound and make sure that none of the pads are shorted to any other. This is what the IF pad looks like now.



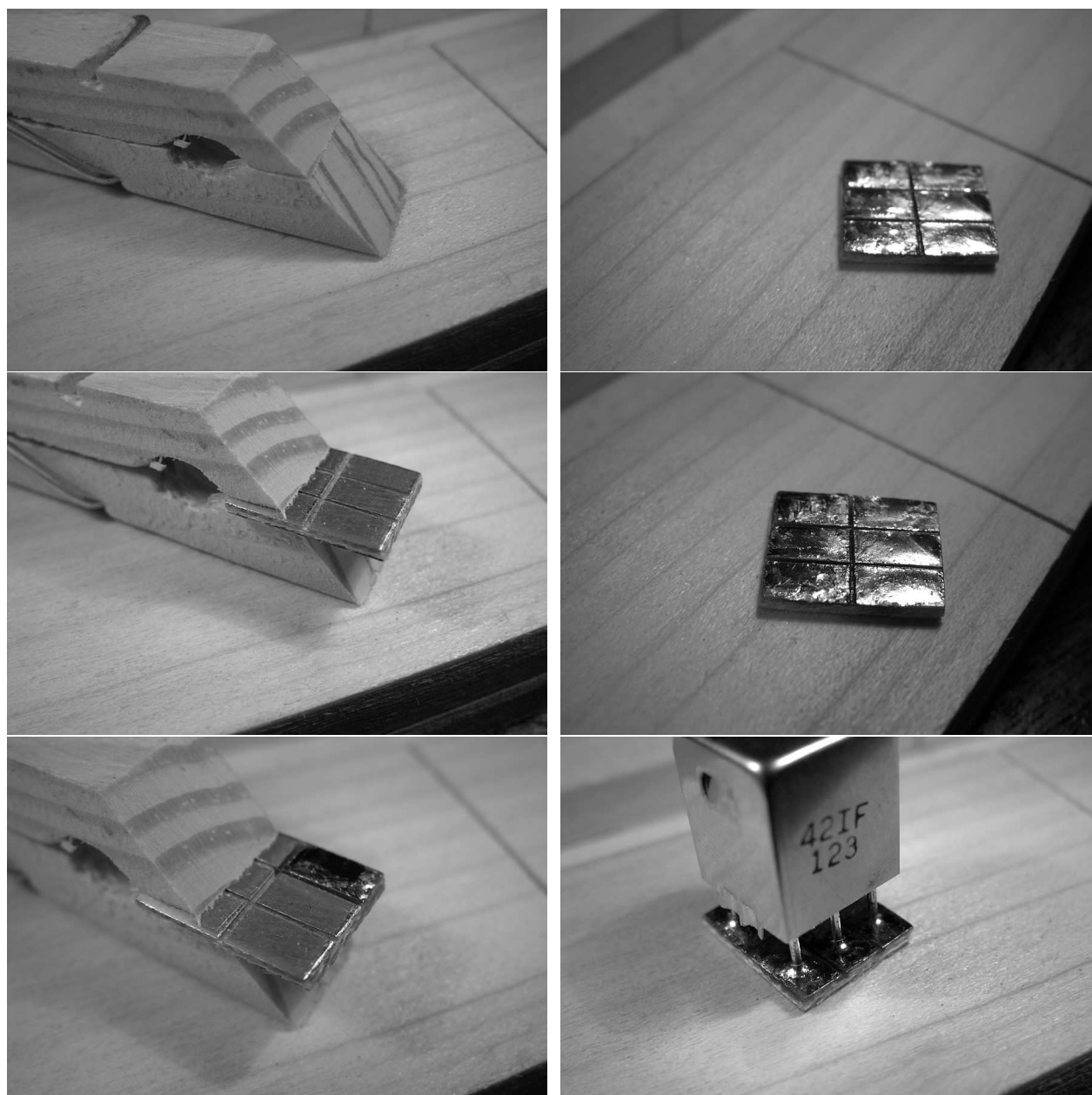

Now we are ready to super glue the pad with IF transformer onto the PC board material. I use only one drop at the center of the pad and I

don't go over board on the amount. Unless this is going into a model airplane I don't expect any IF transformer to be subjected to large forces. The layout diagram for my diagrams shows the IF transformer pad to look as follows. Since there are only five pins on the transformer I show only five pads so that you can correctly orient the pad on the PC board to not confuse the primary and secondary pins.

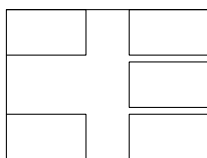

Wire Connections

Now you can call me retentive when it comes to building but I do like to do things neatly as possible without too much of a cost in time and energy. When you need to connect two points separated by a considerable distance then you will need to do a wire. I have below a photo of two short pieces of wire between two points. One white and one red. The white wire is teflon coated and the red one is not. Can you tell the difference? Sure you can and I knew you could. Both are #24 solid wire. It is my preference and you can use what you wish or what you can get. I mail order my wire from a place in California called Apex Jr. and you can find them on the

web. And if you find a source for 100 foot pieces of teflon coated solid wire I'd certainly appreciate hearing from you. I also have stranded wire but I am not a fan of using it for Manhattan building.

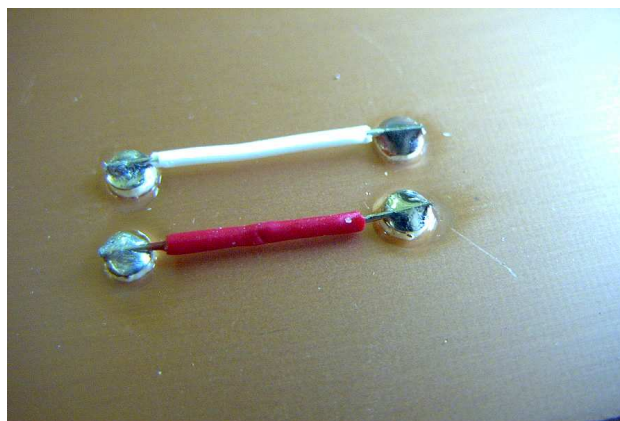

Coax Connections

The other connections from one part of the board may involve using shielded coax in order to prevent RF interference from one part of the circuit to another. For the purpose of such connections I use RG-316U teflon coated coax. It is equivalent to RG-174 which is not teflon coated.

Here is the way that I do the ends in order to make a nice connection. I start with the end of the coax neatly cut. I then take an adjustable wire stripper and remove the outer covering. For my stripper it shows a #18 wire size. The resulting removal looks like this.



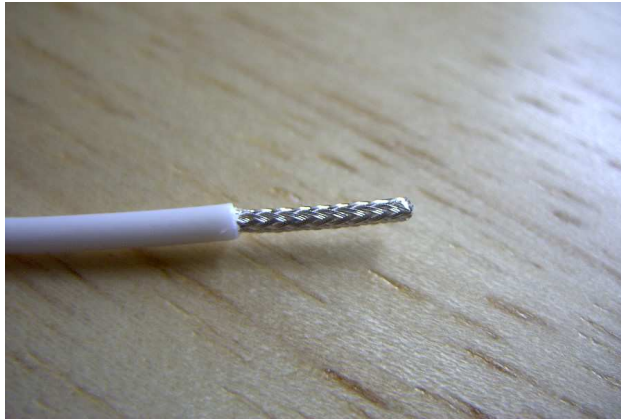

I then very carefully tin only the coax shield adjacent to the coating and try not to tin any more than I possibly can. The tinned shield is difficult to cut with the stripper. Here is the results.

easily slides off the inner workings if the length of coax is short and if you use too much force to try to remove the metal shield while cutting. Sacrifice a 10cm or so piece to practice on with several attempts at this technique before you attempt a work in progress on a project. It is worth the time and effort to learn this. The second thing is to exercise extreme caution and be sure to not sever the inner wire of the coax while removing the shield and later removing the inner insulation.



I then take the wire stripper and make it the next size smaller than that used to remove the outer coating and then remove the untinned part of the outer metal shield. This gives me something that looks like the following.

Oh. Two things to warn you about. The teflon has a very very low coefficient of friction and it



I now reduce the size of the wire stripper to the smallest value and very carefully remove a piece of the inner insulation and then tin the inner wire. The result looks as follows.

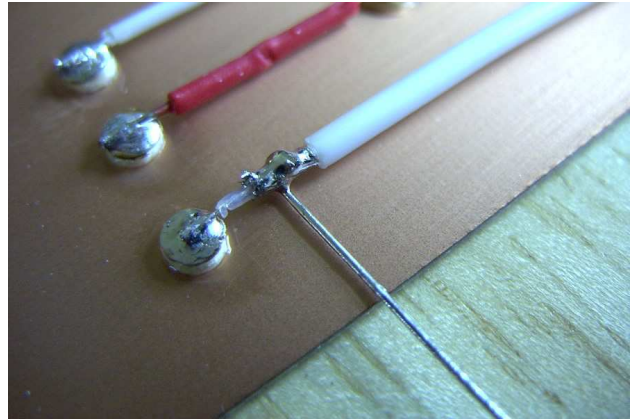

In most applications the shield of the coax is connected to ground. I use a wire clipping and using the needle nose pliers I make a small loop in the end, hook this to the tinned shield, and then solder. This looks like the following.



I can now connect the center conductor to a Manhattan pad and then solder the ground lead to the PC copper plane as shown in the next two photographs. This stuff is fun and it looks good at the same time.



### Crystal Filters

The crystal filter is used in receivers to obtain selectivity. The filter usually consists of 3 or more crystals in series with some capacitors to ground at nodes as part of the filter. Here is a typical circuit schematic for a simple filter without caps at the end nodes. This is just for a demo on how one might layout the physical positioning of pads and components. This is not built in concrete and some imagination and thinking in advance may create a smaller space. This is just for teaching here.

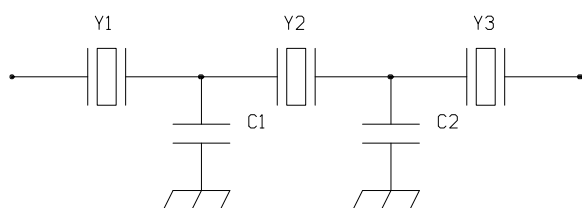

Here are the five components to be soldered to the board and pads. There is a small wire on the top of the crystal cases. That is where a wire was hot welded to the case for grounding and I removed it for this demo. Later I will do a short discussion on crystal case grounding and we will run a series of experiments to look at what the effect of doing same will give us.

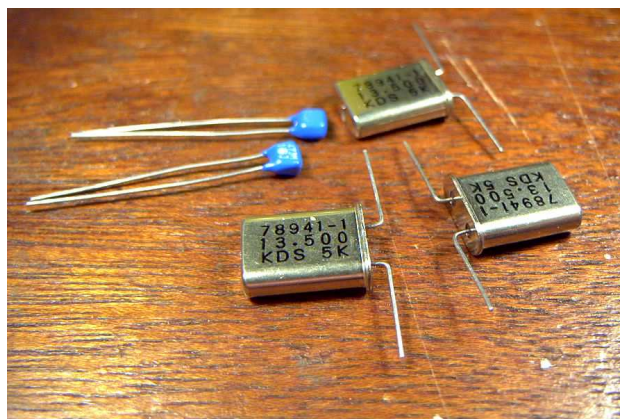

First place the pads on the PC board. I use the parts themselves bent to shape to help in getting good placement and distances.

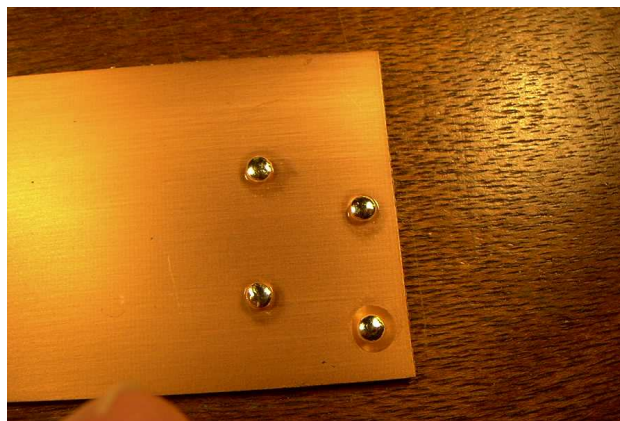

Then I solder the caps into place as they will fit in a tight area and the crystal cases are much higher in physical height above the board.

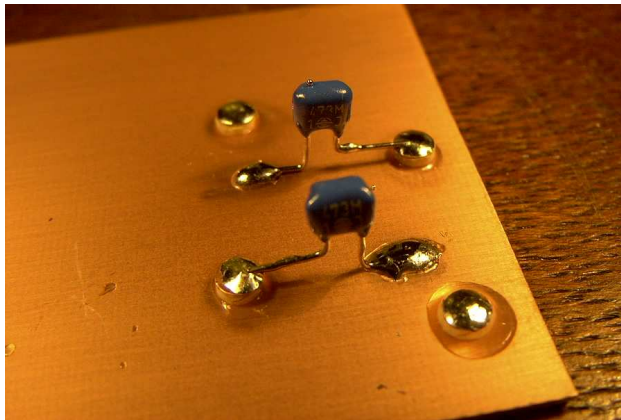

I then solder the center crystal into place.

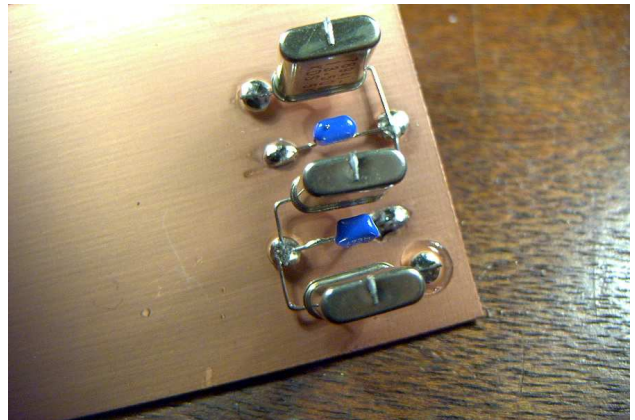

I apologize for the quality of this last series of pictures. The first and the last one came out OK, but the others are too yellow. I did this series without natural sunlight as the sun had set. But the important thing is that you can see what I'm trying to show and this isn't for a science project that I'm being graded.

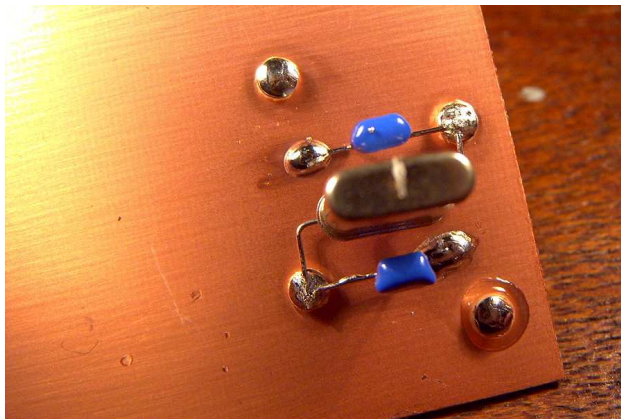

Here is what the physical layout will look like using my graphics routine for doing Manhattan construction layouts.

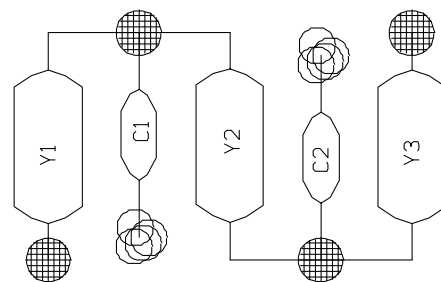

Then solder the two remaining crystals on the ends.

**NN1G Mark III Transceiver**

For a real advanced Manhattan building project I propose that we take Dave Benson's NN1G Transceiver from the January issues of the QRP Quarterly and redo it with some mods to both reduce the cost and make some improvements, although as it stands it is a great little rig in its own right. I'll explain as we go along and I reserve the right to change the layout when I find that something doesn't work as planned. You'll see what I mean as we go along. This is a real experimental project and I'll show you all the nitty gritty details as I write down details.

The next page shows the schematic as it first appeared as a 20 meter transceiver in January 1993 issue of the Quarterly. My schematic drawing routine does not show that T1, T2, T3 and T4 are variable IF transformers because I have not added the lines of code to draw an arrow at an angle through the transformer. I didn't want to add too much clutter to the diagram. Also note that T1 and T2 have the internal cap removed. If you are going to build this rig, then you must get a copy of the original article. And if you want to do a band other than 20 meters then you also need to get a copy of the January 1994 article in which Dave gives you the parts needed to get the rig on 80, 40 and 30 meters.

A 20 METER SUPERHET TRANSCEIVER ---- NN1G MARK III

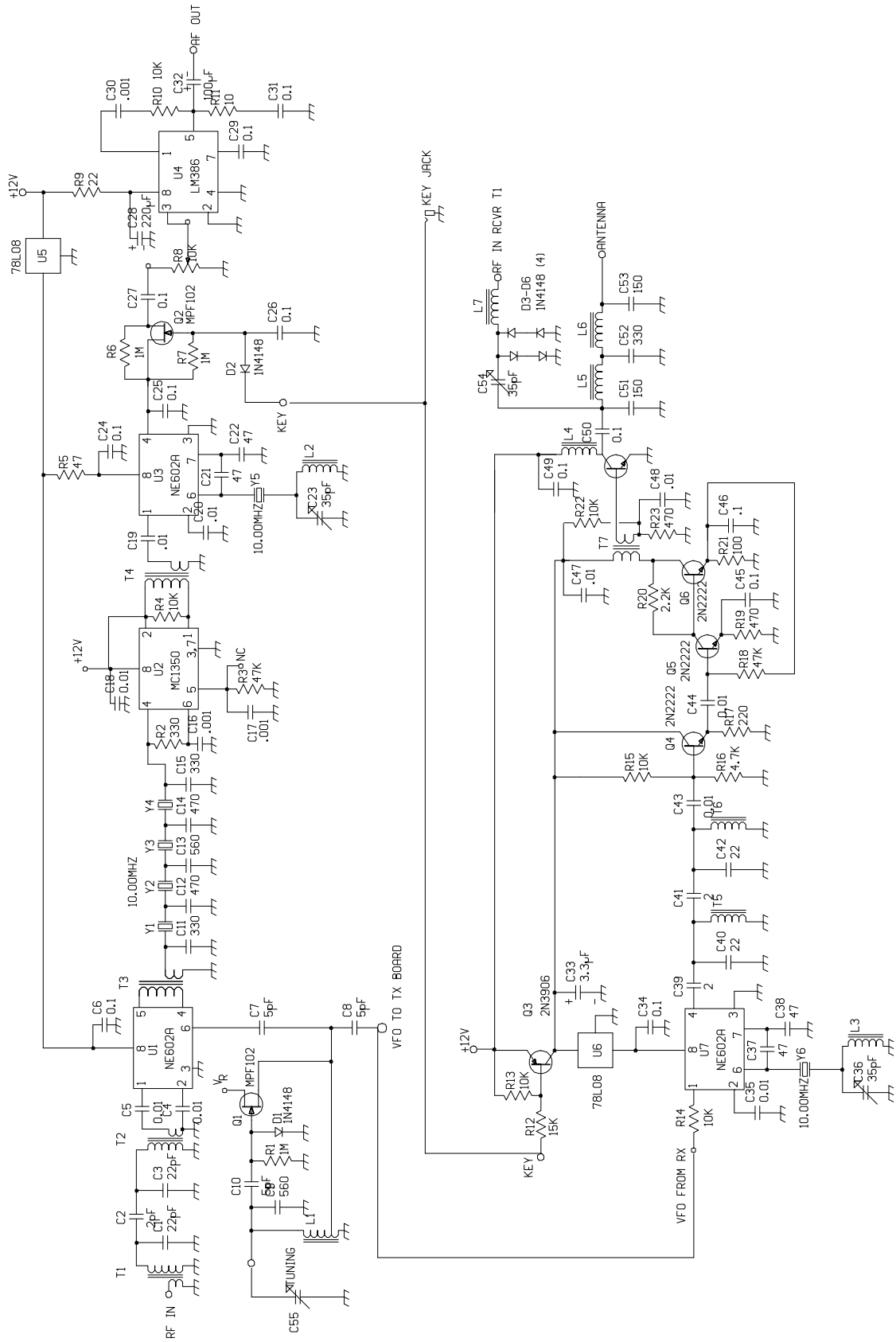

The NN1G Mark III was built on two PC boards that FAR Circuits still sells. Just look at the web site and you can do a Google Search to find it if you need the URL. Here is a photo of one of the PC boards sitting on top of the original article from Dave Benson and two IF transformers. The one on the right is the 7mm IF transformer that was in the original version. This part evidently caused a number of builders both experienced and new a great deal of problems when then removed the internal cap at the bottom of the transformer. If you are not careful you will break the internal wire connection internally and ruin the transformer. It also couldn't handle any current overload also. Dave in the upgraded article the next year went to the 10mm larger transformer shown on the left.

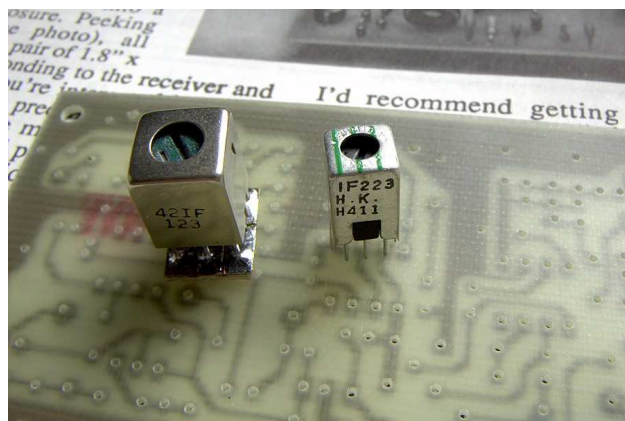

Here is a photograph of a 20 meter version of the rig mounted in a case that I used to sell when I was in Dallas before moving to Prescott. This 20 meter rig allowed me to take first place in several QRP ARCI contests. I still use it oc-

asionally. The only fault with the rig is that the IF is on 10.0000MHz where WWV in Boulder, CO is located and with a good antenna and good conditions you can hear WWV in the background. Nice builtin clock but not a desirable feature to some individuals but you can go with a trap or get another frequency for the IF. We'll come back to this issue later.

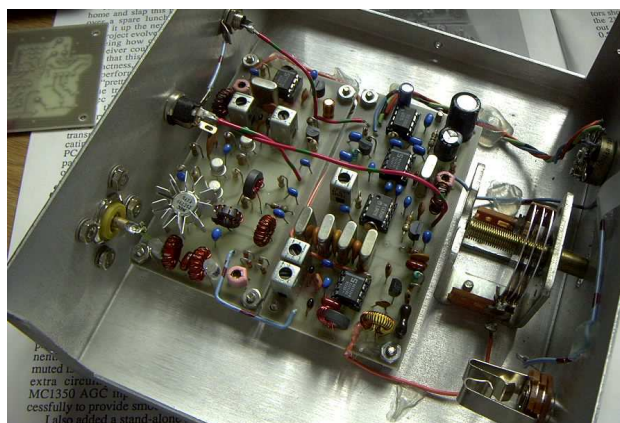

Here is a better photograph with better lighting. The board to the rear is the transmitter section and the receiver is on the front board. Note in both photos that the tuning is done with a mechanical variable capacitor located at the front of the rig. These caps are getting rare and expensive and they do take up a lot of room.



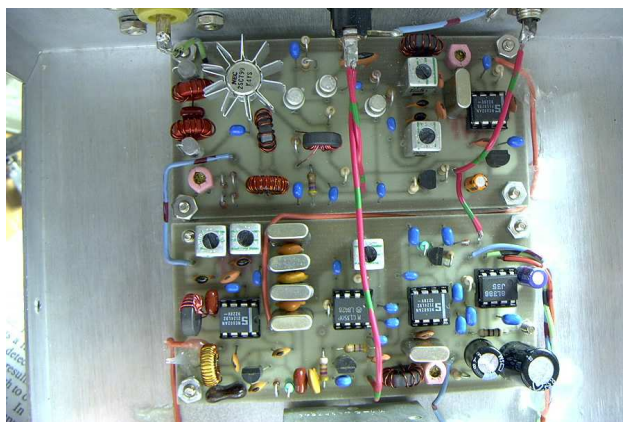

Then looking at the rig from the front. After all these years the case is still unfinished. Just a single tuning mark done with a Sharpie. And you'll note the one quarter of an inch phone jack on the left. Now we've all moved to the one eighth inch stereo earphone jacks so we can use the cheap Sony walkman type earphones.



I have built a number of these old rigs and like them very well. Here is an 80 meter version in a TenTec case. Here the two boards are mounted back to back with spacers and I made some right

angle brass mounts to hold them in place to the bottom of the case. Detailed in the other photograph up close and personal.

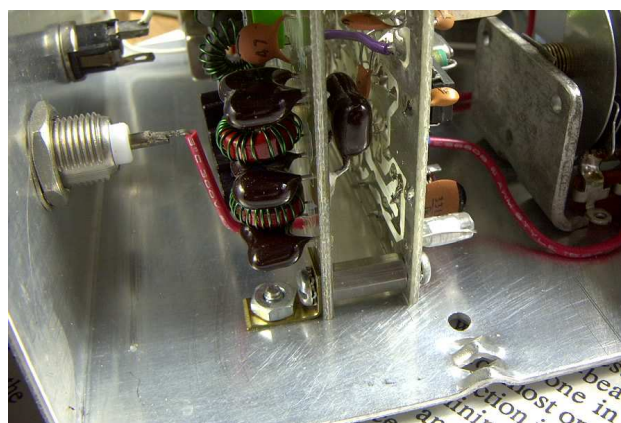
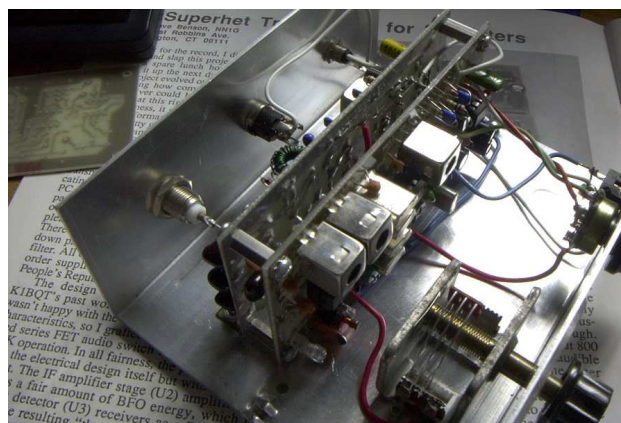

Funny story with this little rig. I had just finished building it and had it on the workbench hooked up to an antenna. I heard a lone station calling CQ from California and I called him and got an exchange. The only problem was that I was in Dallas and I was only running about 80mW which was not the recommended way to

do things on 80 meters.

Here is a closer look at the tuning capacitor.

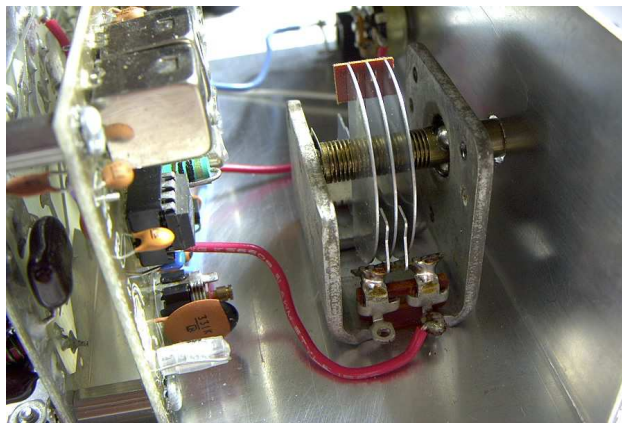
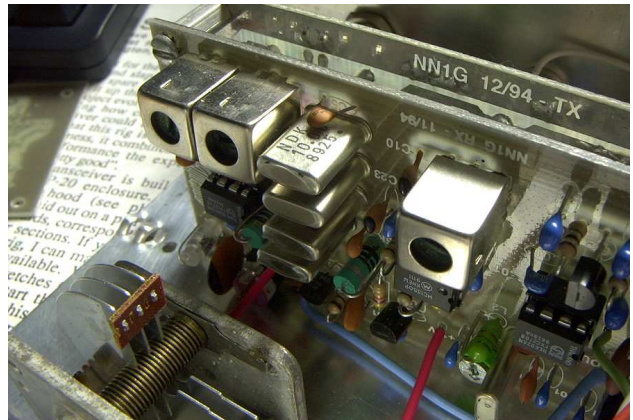

A photo of the input section and crystal IF filter of the receiver. Note that the date on the board is December 1994 a month before the January 1995 article in the QRP ARCI Quarterly. These boards are set up to use the larger IF transformers and the part numbers are printed on the boards. The earlier sets of boards were totally blank on the component side and made building difficult for some builders of the early version.

### Diode Measurements

Here is a plot of some measurements for some diodes. We are mainly interested in Germanium diodes, but we'll also look at some common silicon diodes at the same time. I used the same technique as written up in the SPICE article, also on the web page. I have a variable voltage supply in series with a variable resistor, the diode under test, and an ammeter. I used a high resistance DMM (10 megohms) to measure the voltage source, the voltage drop across the variable resistor and the voltage drop across the ammeter. Do not measure the voltage drop across the diode as you will effect the circuit.

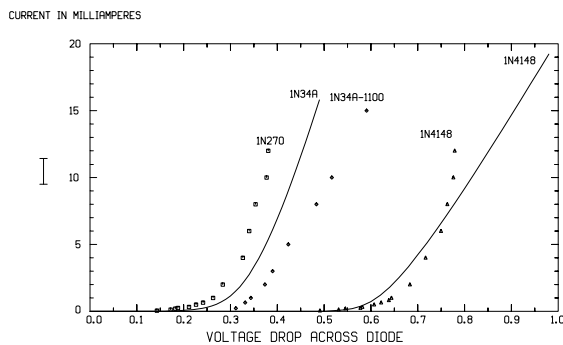

The two solid curves are curves generated by SPICE models for the 1N34A that I got from Roy Lewallen, W7EL, and the 1N4148 curve is from a standard SPICE library. I so far have measured a 1N270 from Radio Shack (I don't think they carry them any more) and the 1N34-1100 curve is from a house numbered part that

I got from some unknown source such as Tanner Electronics in Dallas or Dan's Small Parts. I made a boo boo and did not label the envelope like I usually do when I get new parts. The 1N4148 curve (the symbols near the solid curve) are from a generic part I have in my supply.

We're going to build an RF probe using these diodes and then we'll make it more sensitive for very small RF voltages. You'll see why when I get to crystals and crystal filters.

If you have not done so, go ahead and build the basic RF probe from the article from the AmQRP Club Homebrewer magazine or from the article that I have done on the web page introducing some basics of building Manhattan style. I am going back into the lab and build up several RF probes using both Ge (Germanium) and Si (Silicon) diodes. We will run some tests for sensitivity of these detectors. Then I'll come back to build another RF probe with an amplifier to increase the sensitivity that we will need for some more serious experiments later on.

If you already own some commercial test gear such as the HP milli- and micro-volt RF meter you will be far ahead of the game. You might aid me in using such equipment to test and check my results. I hope to not make basic fundamental errors in the development of this article. But I am not perfect in any way.

This article posted to the web on September 12th, 2003 by Chuck Adams, K7QO. I'll leave this line at the end of this work so that you can check on updates as I complete them. I'll try to do this in a timely manner as winter is coming up rapidly and if you build a rig for 40 or 80 meters it would be nice to have it in time for the season when the bands are quite and useful. I'll try my best on this issue.

Also let me know if you would prefer to have the photographs in black and white for saving expensive color ink in inkjet printers. I have no preference. I don't want to waste my time by doing a B&W issue and another for color photographs. Time is too valuable to be wasted on such trivial details..... Know what I mean kid?