

Introduction

Winkeyer2 is a second generation single chip Morse keyer IC. It is designed to attach to a PC's serial port and provide accurate transmitter keying for a Windows based logging or other ham radio software package. Due to timing latency inherent in the multi-threaded Windows operating system, it is difficult to generate accurately timed Morse. Winkeyer2 buffers ASCII characters sent by a Windows based software application. It then translates them to Morse and directly keys a transmitter or transceiver. In addition, Winkeyer2 has paddle inputs so that an operator can break-in and send using paddles at any time. Winkeyer2 also provides a speed potentiometer interface so that an operator can instantly dial any speed desired.

The host PC communicates to Winkeyer2 over a simple serial interface which can be a USB serial interface. Letters to send, along with operational commands, are sent from the host to Winkeyer2 over the serial link. A substantial feature list is provided allowing the user to precisely tailor Winkeyer2's keying characteristics to a particular transmitter. Winkeyer2 has a very low power requirement; in fact, it was originally designed to be powered from a PC's serial port. In standby it draws under a microamp.

K1EL sells a complete kit with IC, PCB board, USB interface, and enclosure for users who would like to get going with Winkeyer2 quickly and easily. The kit is called WK_USB and includes pushbuttons and battery pack for standalone use.

Features

- 1200 Baud Serial Rx/Tx Interface
- Iambic CW Paddle Interface
- Two Key Output Ports (high true TTL)
- Two PTT Output Ports: (high true TTL)
- 25 ma output sink/source
- Adjustable PTT lead in and tail delays
- Adjustable Speed 5-99 WPM
- Adjustable Weighting and dit/dah ratio
- Adjustable Farnsworth Character Spacing
- Adjustable Keying Compensation
- Autospace
- Sidetone Output
- Standalone Enhanced K12 Mode
- Paddle only sidetone
- Dit/Dah Memory Control
- Adjustable First Dit/Dah correction
- Adjustable Paddle Switchpoint
- Iambic A, B, ultimatic & "Bug" modes
- Speed Pot Interface
- Adjustable speed pot range
- Embedded commands
- 128 character input buffer
- No crystals or oscillators
- Single 5-volt operation
- Current Draw: < 2 ma
- HSCW and QRSS Capability
- Power Down Sleep

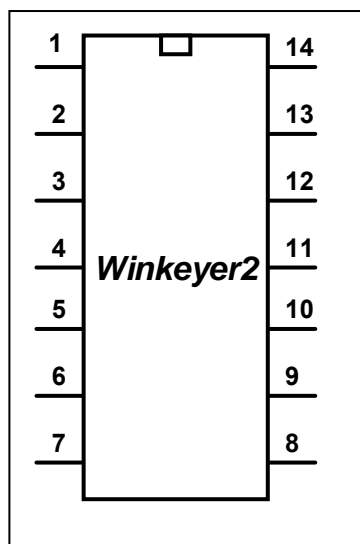

- Pin 1 – Vcc (5.0 volts)**
- Pin 2 – Port 2 Key Output**
- Pin 3 – Port 2 PTT Output**
- Pin 4 – USB Connected Sense**
- Pin 5 – Serial Receive Input**
- Pin 6 – Serial Transmit Output**
- Pin 7 – Port 1 Key Output**
- Pin 8 – Sidetone**
- Pin 9 – Port 1 PTT Output**
- Pin 10 – Speed Pot Analog Input**
- Pin 11 – Right Paddle Input**
- Pin 12 – Left Paddle Input**
- Pin 13 – Switch Array Input Input**
- Pin 14 – Vss (Ground)**

Figure 1 – Winkeyer2 Package & Pinout

Theory of Operation

This section will describe how the Winkeyer2 works. As shown in Figure 1, the host PC is connected to Winkeyer2 over a serial COM port, which can be a USB port supporting virtual COM. Winkeyer2 is a slave to the PC in that it receives commands and data from the PC and acts upon them. The PC can send commands while Winkeyer2 is sending Morse allowing dynamic configuration changes. Winkeyer2 will communicate back to the host for four reasons:

- 1) Inform the host of a status change in Winkeyer2.
- 2) Inform the host of a speed pot or pushbutton change (WK2 mode only).
- 3) Respond to a request for information from the host.
- 4) Echo back morse in ASCII as it's being sent from either the serial port or the paddles.

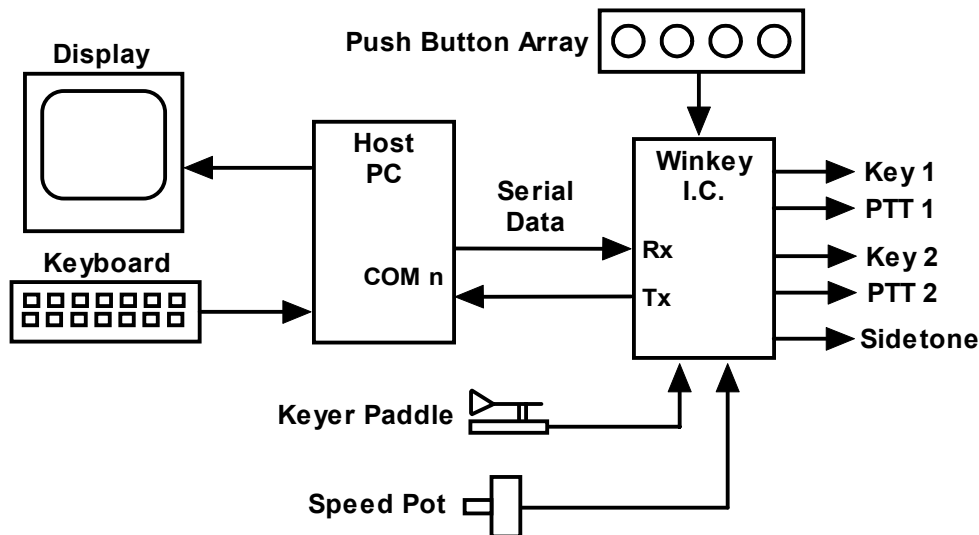

Figure 2 – Winkeyer2 to PC Connection

There are two types of serial input from the host to Winkeyer2: Command and Data. Commands modify Winkeyer2's operation in some way, for example changing operating speed, pausing transmission, or asking for status. Data can be letters, numbers, or prosigns that are to be sent in Morse. Commands and data are processed differently in Winkeyer2. Data is put into a serial buffer that allows the host to send data ahead of the Morse being sent. The size of this buffer is 128 characters and is a FIFO which is an acronym for First In First Out. This means that characters are taken out in the order they were put in. Since there can be a considerable delay from host input to Morse output, commands bypass the input FIFO and are acted upon immediately. This allows changes to be made while sending is underway.

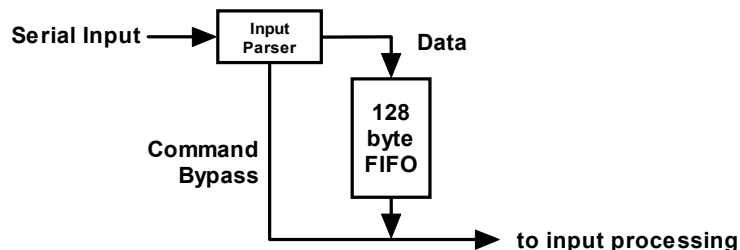

Figure 3 – Data and Command Flow inside Winkeyer2

Since there are times when you don't want commands to take effect immediately, Winkeyer2 allows commands to be buffered. This means that the command is placed in the serial buffer and won't be acted on until it comes out of the buffer. An example of the use of a buffered command would be to send two words at two different speeds, the first at 15 WPM and the second at 20 WPM. By placing a buffered speed command

between the words the speed will not be changed until the first word is completely sent. Not all, but many of the immediate commands can be entered as buffered commands.

Communication from Winkeyer2 to the host operates in a loosely coupled manner. This means that the host never issues a command and waits for a response. Instead, the host sends a request for information and Winkeyer2 queues this request and will respond to the host when processing time allows. Winkeyer2 processes tasks in parallel, there may be other bytes waiting to be sent back to the host before the latest request can be handled. Rather than wait for a return, the host should divide its Winkeyer2 driver interface into two parts, one part that issues command bytes and a second part that checks for returned bytes and processes them when they arrive. Following is a bit of psuedo-code that illustrates this concept. It will make more sense as you learn about the Winkeyer2 command set.

```
Serial Comm Thread {
  while (1) {
    if (host has a command to send to Winkeyer2) {
      send command to winkeyer2;
    }
    else if (Winkeyer2:uart_byte_ready) {
      wkbyte = Winkeyer2:uart_read();
      if (( wkbyte & 0xc0) == 0xc0 {
        it's a status byte. (Host may or may not have asked for it.)
        process status change, note that it could be a pushbutton change
      }
      else if ((wkbyte & 0xc0) == 0x80) {
        it's a speed pot byte (Host may or may not have asked for it.)
        process speed pot change
      }
      else {
        it must be an echo back byte
        if (break-in==1) { it's a paddle echo }
        else { it's a serial echo }
      }
    }
  }
}
```

Notice that unless Winkeyer2 has something for the host to read, the host continues to process outgoing commands and other tasks. Also note that speed pot and status bytes can be unsolicited, in other words Winkeyer2 can send these at any time a state change occurs inside Winkeyer2. Echo back bytes are also unsolicited as they are based on asynchronous Morse sending. The host has to be able to handle these as they occur. If host processing is slow, a serial input buffer on the host side is required to make sure no returned bytes are missed.

Paddle Input Priority

Winkeyer2 accepts input from either its serial port or iambic paddle. The paddle will always take priority and will interrupt serial data, automatically clearing Winkeyer2's serial input buffer. When a paddle break-in occurs, any additional serial data that arrives from the host will be processed, but will be ignored unless it is an immediate command. After paddling ceases, Winkeyer2 will pause for one word space time before it resumes serial data transmission.

Standalone Keyer Mode

Winkeyer2's primary purpose is to provide accurate Morse keying to a Windows based application. The most often requested feature from users of WK1 was to also allow WK to be run by itself, not connected to a computer. In response, a complete standalone keyer has been included in Winkeyer2.

In most respects the standalone keyer is completely separate from the host mode keyer. This means that the standalone keyer has its own configured state that is preserved when changing to host driven mode. Configuration changes issued while under host mode will be cancelled when returning to standalone mode. A simple Windows application is available from K1EL called WK2MGR which can be used to set the standalone configuration and message contents from the PC. In addition settings and messages can be entered by paddle commands in standalone mode.

Winkeyer2 standalone mode is an emulation of the popular K1EL K12 keyer IC command set. Several enhancements are included as documented in the Standalone keyer section.

Power Up Default State

On power up, Winkeyer2 comes up in standalone mode and stays in that mode until it receives a Host Open command from a PC host. At that time standalone mode is suspended. When the host takes over it should download a block of initialization parameters (see Load Defaults command) to set the operating state as desired and to sync Winkeyer2 settings with the host settings. All applications interfacing to WK2 should always issue an Admin:Close command upon application shutdown to return WK2 back to standalone mode. This allows the keyer to be used in standalone mode while still attached to the PC. When WK2 is physically disconnected from the host it automatically goes into standalone mode even if a Close command was not issued.

While WK2 is attached to a PC com port in the closed state it will accept ADMIN commands. This allows an application to set WK2/WK1 mode, upload or download standalone messages and standalone settings.

Winkey Lockup Recovery

Once Winkeyer2 is connected to a host it should not be physically disconnected while the host application is active. Accidents do happen and if the USB cable is pulled in the middle of a command or data exchange Winkeyer2 can get locked up. It's not very likely but it can happen. A provision is included to easily get Winkeyer2 back in operation again. Press and hold the command button until Winkeyer2 responds with a restart response. If Winkeyer2 was stuck open a **C** will be sent in sidetone. If Winkeyer2 needed a reboot it will echo an **R**.

Pushbutton Notification

Winkeyer2 supports pushbutton inputs intended primarily for standalone operation. One pushbutton is designated as the Command push button and is used to initiate paddle commands. The other pushbuttons are used to enter or play recorded Morse messages. A provision has been included to allow the host to be notified of pushbutton state change while Winkeyer2 is connected to a host. To take advantage of this new WK2 feature, the host application must issue an Admin:Set WK2 Mode command. This allows pushbutton status to be returned by changing the format of the status command. Standalone operation is unaffected by Winkey mode setting.

USB Sense

Winkeyer2 was designed with USB interfacing in mind. Its USB sense input should be asserted high when a USB port is attached. If the USB port is switched to Standby or if disconnected from the PC, USB Sense should be pulled low. When this input is de-asserted, WK2 is allowed to go into low power sleep mode. Note that while connected to the host and opened, WK2 will not go into low power standby.

Host Mode Command Descriptions

This section documents the commands that are sent from the host to Winkeyer2 over the serial interface. Commands are special hex codes that are sent to Winkeyer2. These codes range from 0x01 through 0x1F. In this document a hex value will be presented in angle brackets, for example <02>. Some commands have one or more parameters sent immediately after the command code is sent, this will be documented as the command code followed by a value: <02><nn> where nn is a single byte binary value. The notation [c] represents a single ASCII character sent to Winkeyer2 as a single serial byte.

Immediate Commands

These commands are processed as soon as they are received, they bypass the input buffer.

Immediate Admin Commands

- **Admin** <00><nn> **nn is a value from 0 to 8**

After power-up the host interface is closed, serial status, echo, or port change data will not be sent to the host. The only commands WK2 will accept are Admin commands. Admin commands are received, processed and any return status or data will be sent back immediately. Admin commands calibrate the interface, reset WK, obtain debug information and open the interface. With the exception of the Admin:Close command, all Admin commands should only be issued while the host interface is closed. Following are descriptions of the Admin commands:

- 0: Calibrate** This is an historical command preserved for WK1 compatibility. It is no longer required for the more accurate PIC the WK2 is implemented on. You can issue the command and it will not cause ill effects, but it is not processed by WK2. The command syntax is:
<00><00> pause 100 mSec <FF>
- 1: Reset** Resets the Winkeyer2 processor to the power up state. Do not send this as part of the initialization sequence. Only send this if you want to do a cold reboot of WK2.
- 2: Host Open** Upon power-up, Winkeyer2 initializes with the host mode turned off. To enable host mode, the PC host must issue the admin:open command. Upon open, Winkeyer2 will respond by sending the revision code back to the host. The host must wait for this return code before any other commands or data can be sent to Winkeyer2. Upon open, WK1 mode is set.
- 3: Host Close** Use this command to turn off the host interface. Winkeyer2 will return to standby mode after this command is issued. Standby settings will be restored.
- 4: Echo Test** Used to test the serial interface. The next character sent to Winkeyer2 after this command will be echoed back to the host.
- 5: Paddle A2D** Historical command not supported in WK2, always returns 0.
- 6: Speed A2D** Historical command not supported in WK2, always returns 0.
- 7: Get Values** Returns all of the internal setup parameters. They are sent back in the same order as issued by the Load Defaults command. Again, this command is a diagnostic aid. Only issue this command when host interface is closed.
- 8: Reserved** *K1EL Debug use only*
- 9: Get Cal** Historical command not supported in WK2, always returns 0.
- 10: Set WK1 Mode** Disables pushbutton reporting
- 11: Set WK2 Mode** Enables pushbutton reporting, alternate WK status mode is selected.
- 12: Dump EEPROM** Dumps all 256 bytes of WK2s internal EEPROM.

13: Load EEPROM Download all 256 bytes of WK2's internal EEPROM.

14: Send Standalone Message Command WK2 to send one of its internal messages. The command syntax is: <00><14><msg number> where number is 1 through 6

Immediate Host Mode Commands.

- **Sidetone Control** <01><nn> **nn is a value determined from Table 1 & 2**

In WK2 sidetone is always enabled and pin 8 functions as the sidetone square wave output. The following tables define the format of value **nn**. *Note that these frequencies are slightly different than WK1*

Value nn Bits	Function
7 (MSB)	Enable Paddle Only Sidetone when = 1
6-4	Unused set to zero
3-0	Sidetone frequency N (See Table 2 below)

Table 1 – Sidetone Control Assignments

N	Frequency	N	Frequency
0x1	4000 Hz	0x6	666 Hz
0x2	2000 Hz	0x7	571 Hz
0x3	1333 Hz	0x8	500 Hz
0x4	1000 Hz	0x9	444 Hz
0x5	800 Hz	0xa	400 Hz

Table 2 – Sidetone Selection Table

The most significant bit of the frequency byte controls the paddle only sidetone feature. In WK2 you can choose to only use sidetone for paddle entry and mute it for CW sourced from the host port. This is called Paddle Only Sidetone and is selected by setting the MSB of the sidetone control value.

- **Set WPM Speed** <02><nn> **nn is in the range of 5-99 WPM**
Example: <02><12> set 18 WPM

Set a new Morse operating speed, this command takes effect as soon as Winkeyer2 receives it. If speed is set to zero then Winkeyer2 will take its speed setting directly from the speed pot., this is the reset default.

- **Set Weighting** <03><nn> **nn is in the range of 10-90%**
Example: <03><32> for weight=50

This command allows a proportional amount to be either added or subtracted from the length of all dits and dahs sent. A value of 50 (0x32) selects no weighting adjustment. Values less than 50 reduce weighting and values greater than 50 increase weighting. Note that weighting does not affect sending speed because any increase in keyed time is subtracted from spacing time. Reduction in weighting results in a thinner sounding keying while increased weighting results in a heavier sound. Since weighting tracks speed, a given weighting will sound the same at all speeds.

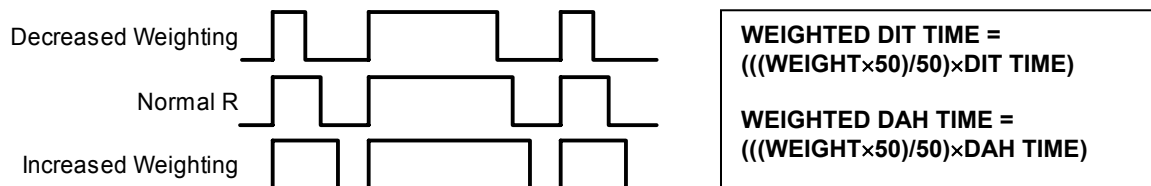

Figure 5 - Weighting Example

- **Set PTT Lead/Tail** <04><nn1><nn2> nn1 sets lead in time, nn2 sets tail time
both values range 0 to 250 in 10 mSecs steps
Example:
<04><01><A0> lead-in = 10 mSecs, tail = 1.6 sec

Winkeyer2 provides a transmitter PTT output for each key output that can be used to switch a transmitter or linear amplifier over to transmit mode in advance of actual CW keying. You have control over the time delay between when PTT is asserted and when CW keying will start, this is lead-in. You also have control over how long the transmitter will stay in transmit after keying has stopped; this is the tail delay. The lead/tail settings apply to both key ports.

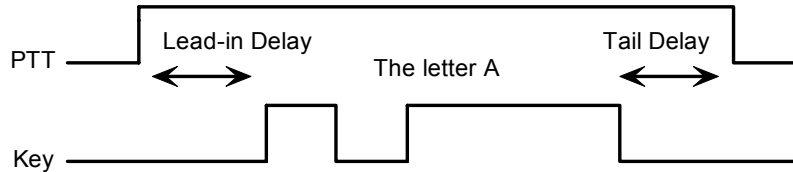

Figure 6 – PTT Lead-in and Tail Example

- **Setup Speed Pot** <05><nn1><nn2><nn3> nn1 = MIN, nn2 = RANGE, nn3 = don't care

This command sets the limits for the speed pot. MINWPM sets the lowest value returned; WPMRANGE indirectly specifies the maximum value returned. For example if MINWPM=10 and WPMRANGE=15, the full pot swing values, min to max, would be 10 to 25 WPM. Note that the max value is MINWPM+WPMRANGE. The value of the third parameter is not used but it must be included to maintain backward compatibility for applications supporting only WK1 keyers. Recommendation is to set this to zero but any value is accepted.

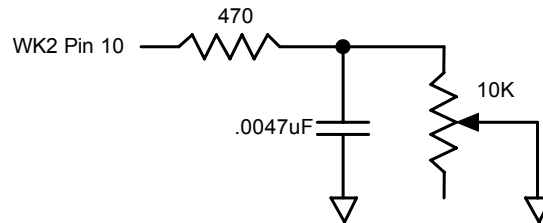

Figure 7 – Speed Pot Configuration

- **Set Pause State** <06><nn> nn = 01 pause, value = 00 unpause

When Winkeyer2 is paused, sending will stop immediately and will not resume until an unpause state is set. The current character being sent in Morse will be completed before pause. Note that the Clear Buffer command will cancel pause..

- **Get Speed Pot** <07> no parameter
Request to Winkeyer2 to return current speed pot setting.

This command will cause a speed pot command request to be queued in Winkeyer2 and it will be acted on as soon as possible. Depending on current processing load the pot status byte will be sent no longer than 200 milliseconds after command receipt. The application should not wait for a response but process the returned data in an unsolicited status handler. The returned value will range from 0 to 31 and is governed by the setting of the MINWPM and WPMRANGE values set via the POTSET command. The returned value will

be the actual speed pot value minus the MIN_WPM setting. This allows the speed pot to be windowed into any 32 step range from 5 to 99 WPM. The two MS Bits of a Speed Pot status byte will always be 10:

1	0	6 bit value in WPM
---	---	--------------------

Figure 8 - Speed Pot Status Byte Format

- **Backspace** **<08>** **no parameters**

Backup the input buffer pointer by one character. This command is only meaningful if there is something in the serial input buffer, otherwise it is ignored.
- **Set PinConfig** **<09><nn>** **low nibble determines how output pins are mapped**
high nibble controls ultimatic mode and hang time

WK1's 8 pin package forced Pin 5 to be a shared resource, it could be assigned as a PTT output, a Sidetone output, or a secondary Key output: If it was assigned as a PTT output, that meant it was not possible to output sidetone. Likewise if it was assigned as a secondary Key output, sidetone or PTT were not allowed.

Bit 7-4	Bit 3	Bit 2	Bit 1	Bit 0
See Below	Pin5 KeyOut Enable	Pin3 KeyOut Enable	Pin 5 Sidetone Enable	Pin5 PTT Enable

Figure 9 – WK1 PINCFG Format

WK2 has a dedicated sidetone pin, two PTT outputs, and two Key outputs. No sacrifices are necessary. The pin config assignments are compatible with WK1 for backwards software compatibility but allow much more flexibility than WK1. For example Bit 0 specifies whether PTT should be used, Bit 1 specifies whether Sidetone is enabled, and Bits 2 and 3 select which keyport is active. If Key port 1 is active, PTT1 will be asserted in sync with KEY1 if the PTT enable is asserted, likewise for Port 2.

Bit 7-4	Bit 3	Bit 2	Bit 1	Bit 0
See Below	KeyOut 1 Enable	KeyOut 2 Enable	Sidetone Enable	PTT Enable

Figure 10 – WK2 PINCFG Format

The PINCFG register is overloaded with two additional features, Dit/Dah priority and Paddle hang time. These settings are allocated to the upper four bits as follows:

Bit 7	Bit 6	Bit 5	Bit 4	Bit 3-0
Priority 1	Priority 0	Hang Time 1	Hang Time 0	See Above

Figure 11 – Priority/Hang Time Format

Priority = 00 Normal Ultimatic
 Priority = 01 Will send dahs when both paddles are pressed in Ultimatic mode
 Priority = 10 Will send dits when both paddles are pressed in Ultimatic mode
 Priority = 11 Undefined

HangTime = 00 Wait 1.0 letterspace before ending paddle insertion
 HangTime = 01 Wait 1.33 letterspace before ending paddle insertion
 HangTime = 10 Wait 1.66 letterspace before ending paddle insertion
 HangTime = 11 Wait 2.0 letterspace before ending paddle insertion

Hang Time is like tail time in that it holds PTT on between paddle presses, but is proportional to sending speed by virtue of the fact that it is measured in word space time while tail time is measured in absolute milliseconds. **Tail time must be set to zero to enable HANG time operation.**

• **Clear Buffer** **<0A>** **no parameters**

This command will reset the input buffer pointers to an empty state. It is a general clear also in that Tune and Pause are also cancelled by this command.

Clear Buffer can be sent at any time to abort a message, abort a command, or to clear the serial buffer. It will cancel any Morse character in progress immediately ending it in midstream if necessary.

• **Key Immediate** **<0B><nn>** **nn = 01 keydown, n = 00 keyup**

Use this command to implement a tune function. Once asserted, key down will remain in effect until either a key immediate with a zero value is received or the internal tune watchdog timer expires. The tune timer is hard coded to a value of 100 seconds and cannot be disabled. The key down can be aborted either by the paddles or by a clear buffer command.

• **Set HSCW** **<0C><nn>** **nn = the lpm rate divided by 100**

Winkeyer2 supports HSCW (High Speed CW) transmit rates through the use of this immediate command.

For example nn=20 selects 2000 lpm and nn=35 selects 3500 lpm. Any rate from 1000 to 8000 can be picked although only a handful are actually used by radio amateurs. In the US, common rates are 1000, 2000, 4000 and 6000 lpm while in Europe 1000, 1500, 3000, 4000 lpm are common.

• **Set Farns WPM** **<0D><nn>** **nn is in the range of 10-99**

Example: <0D><12> for Farnsworth=18 WPM

Farnsworth spacing is useful for CW practice because it encourages you to learn characters by sound not individual dits and dahs. In Winkeyer2, Farnsworth is implemented by sending letters at a fixed rate of **nn** WPM regardless what the WPM sending rate is. Spacing between characters is determined by the sending rate. When the WPM rate is set above the Farnsworth WPM, Farnsworth is automatically disabled.

• **Set Winkeyer2 Mode** **<0E><nn>** **nn = Mode bit field in binary**

Example: <0E><13> set bits 4,1,0, clear the rest

The operational mode of Winkeyer2 can be modified by directly altering its internal mode register. This register is made up of eight bits which each control a particular mode.

Mode Bit	Function
7 (MSB)	Disable Paddle watchdog
6	Paddle Echoback (1=Enabled, 0=Disabled)
5	Key Mode: 00 = Iambic B 01 = Iambic A 10 = Ultimatic 11 = Bug Mode
4	
3	Paddle Swap (1=Swap, 0=Normal)
2	Serial Echoback (1=Enabled, 0=Disabled)
1	Autospace (1=Enabled, 0=Disabled)
0 (LSB)	CT Spacing when=1, Normal Wordspace when=0

Figure 12 – Winkeyer2 Mode Selection Table
The Winkeyer2 mode register is cleared at reset.

Bit 7

Winkeyer2 has a paddle watchdog counter that will disable the key output after 128 consecutive dits or dahs. This is to guard against the paddles being accidentally keyed continuously. By default the paddle watchdog is on but it can be turned off by setting this mode bit.

Bit 6

When this bit is set to one all characters entered on the paddles will be echoed back to the host. From the host perspective paddle echo and serial echo are the same, in either case the letter sent in Morse by

Winkeyer2 is echoed back to the host. The echo occurs after the letter has been completely sent. The host can determine the source by the sense of the "break-in" status bit. If the bit is high when the echoed letter comes in then the letter's source was from the paddles, if break-in is low the source is from the serial port.

Bit 5,4

Winkeyer2 supports Iambic A, B, Ultimatic, and Bug keying modes. In Iambic mode Winkeyer2 makes both dits and dahs automatically based on which paddle you press. In bug mode Winkeyer2 makes the dits and you make the dahs. You also can use bug mode to operate in straight key mode or if you want to key through Winkeyer2 with a different keyer, simply set bug mode and use the dah input to key Winkeyer2.

In either Iambic mode, alternating dits and dahs are sent while both paddles are held closed. In mode B an extra alternate dit or dah is sent after both paddles are released. In Ultimatic mode when both paddles are pressed the keyer will send a continuous stream of whichever paddle was last pressed.

Bit 3

Paddle swap: this is a nice feature to have when right and left handed ops want to share the same keyer.

Bit 2

Echo back is a feature that is included to allow a host application to stay exactly in sync with Morse letters sent. When this mode is enabled all data taken out of the serial buffer is sent to the host after it has been sent in Morse. This allows the host to reconcile differences in timing introduced by Winkeyer2's internal 32 byte serial buffer. Note that only letters, and not buffered commands with their parameters or wordspaces, are echoed back to the host.

Bit 1

Here is how autospace works: If you pause for more than one dit time between a dit or dah Winkeyer2 will interpret this as a letter-space and will not send the next dit or dah until full letter-space time has been met. The normal letter-space is 3 dit spaces. Winkeyer2 has a paddle event memory so that you can enter dits or dahs during the inter-letter space and Winkeyer2 will send them as they were entered. With a little practice, autospace will help you to send near perfect Morse.

Bit 0

Winkeyer2 supports contest spacing which reduces the wordspace time by one dit. Instead of 7 dits per wordspace, Contest spacing selects six dits per wordspace.

• **Load Defaults** **<0F><value list>** **value list is a set of 15 binary values**

This command is provided to allow all the operating parameters to be loaded into Winkeyer2 in one block transfer. The values are binary and must be loaded in order. The values are exactly the same as those loaded for the individual commands. The preferred time to issue this command is at reset just after the interface has been opened. Issuing this command while sending Morse is not advised.

- | | | |
|----------------------|-----------------------|--------------------------|
| 1) Mode Register | 2) Speed in WPM | 3) Sidetone Frequency |
| 4) Weight | 5) Lead-In Time | 6) Tail Time |
| 7) MinWPM | 8) WPM Range | 9) 1st Extension |
| 10) Key Compensation | 11) Farnsworth WPM | 12) Paddle Setpoint |
| 13) Dit/Dah Ratio | 14) Pin Configuration | 15) Don't care, set to 0 |

Figure 13 - Default Value List in order of issuance:

• **Set 1st Extension** **<10><nn>** **nn is in the range of (0 to 250) × 1 mSecs**
Example: <04><80> sets lead in to 80 mSecs

Winkeyer2 addresses a problem often encountered when keying older transceivers that have a slow break-in response. Due to a slow receive to transmit changeover time, the first dit or dah of a letter sequence can be chopped and reduced in length. Adding a fixed amount to the first element of a sequence can compensate for this. For example, an R would be sent with the first dit elongated but the subsequent dah-dit sent normally. The compensation amount is transceiver dependent and is generally independent of sending speed. Note though that this is usually only a noticeable problem at higher CW speeds >25 WPM.

A challenge in this scheme is to determine when sending has stopped long enough to cause the transceiver to switch back to receive. If it has it'll require a new first element correction on the next sequence. Winkeyer2 uses the PTT tail timer to determine this, set the tail timer to roughly match the transmit to receive changeover time of the transceiver and things will work fine. It takes some trial and error to get it set up right so make sure you preserve the value and load it as a defaults after reset.

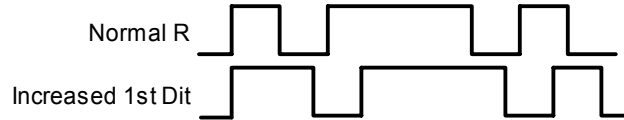

Figure 14 – 1st Extension Example

- **Set Key Comp** **<11><nn>** **nn is in the range of (0 to 250) × 1 mSecs**
Example: <11><B4> sets key comp to 180 mSecs

Keying Compensation allows a fixed amount to be added to the length of all dits and dahs. QSK keying on modern transceivers can cause shortening of the dit and dah elements which is especially noticeable at high speeds. Winkeyer2 allows the length of the dit and dah elements to be increased uniformly to compensate for this. The adjustments are made in units of one-millisecond steps. The maximum adjustment is 250 mSecs. Key compensation is very similar to Weighting in that any adjustment added to the dits and dahs is subtracted from the spacing so the speed is not changed. The difference between weighting and compensation is that compensation is independent of speed, so if 10 msec of key compensation is selected 10 msec will be always be added regardless of speed. So be careful at high speeds and large values of key compensation, you may end up with no inter-element space.

When nn = 00 there is no adjustment while nn=12 will add twelve mSecs.

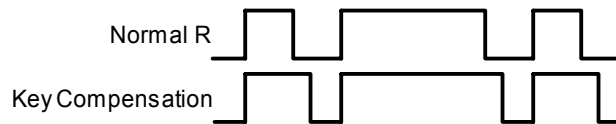

Figure 15 – Keying Compensation Example

- **Null Command** **<13>** **this command is a NOP**
- **Set Paddle Switchpoint** **<12><nn>** **nn is in the range of 10-90%**
Example: <03><37> for sensitivity=55

This controls when Winkeyer2 will start looking for a new paddle press after sensing the current one. If there is not enough delay the keyer will send unwanted dits or dahs, if there is too much delay it bogs you down because you can't get ahead of the keyer. The default value is one dit time (50) and is adjustable in percent of a dit time. Faster operators report a setting somewhat less than default is more pleasing. If the paddle sensitivity is set to zero, dit and dah paddle memory is disabled. The delay is calculated with this formula:

DELAY_TIME = (SWITCHPOINT×DIT_TIME)/50 where Switchpoint is a value between 10 and 90.

- **Software Paddle** **<14><nn>** **nn = 00 paddle up, n=01 dit, n=02 dah, n=03 both**

This command provides a way to assert paddle inputs from the host. The PC application would convert keydown codes to Software Paddle commands. Due to the limited response time of the keyboard, operating system, and serial communication the best you can do is around 20 WPM. The paddle watchdog will be used for this interface as if it were a normal paddle input.

• **Request Winkeyer2 Status <15> no parameter, Return Winkeyer2's status byte**

This command is used to queue a request to Winkeyer2 to send its current operating state. The status byte returned consists of a bit field that is defined by the following table. The three MSBs of the the status byte are always 110. Note that in WK2 mode bit 3 identifies the status byte as a pushbutton status byte. WK2 mode is set by the ADMIN command 11 before WK is opened.

Status Bit	Name	Definition
7 (MSB)	Tag	1
6	Tag	1
5	Tag	0
4	WAIT	WK is waiting for an internally timed event to finish
3	KEYDOWN	Keydown status (Tune) 1 = keydown
2	BUSY	Keyer is busy sending Morse when = 1
1	BREAKIN	Paddle break-in active when = 1
0 (LSB)	XOFF	Buffer is more than 2/3 full when = 1

Figure 16 – Winkeyer2 Status Definition WK1 compatible mode

Status Bit	Name	Definition
7 (MSB)	Tag	1
6	Tag	1
5	Tag	0
4	WAIT	WK is waiting for an internally timed event to finish
3	0	This is a WK Status Byte
2	BUSY	Keyer is busy sending Morse when = 1
1	BREAKIN	Paddle break-in active when = 1
0 (LSB)	XOFF	Buffer is more than 2/3 full when = 1

Figure 17 – Winkeyer2 Status Definitions (WK2 Mode)

Status Bit	Name	Definition
7 (MSB)	Tag	1
6	Tag	1
5	Tag	0
4	PB4STAT	1 when PB4 pressed, 0 when PB4 unpressed
3	1	This is a pushbutton status byte
2	PB3STAT	1 when PB3 pressed, 0 when PB3 unpressed
1	PB2STAT	1 when PB2 pressed, 0 when PB2 unpressed
0 (LSB)	PB1STAT	1 when PB1 pressed, 0 when PB1 unpressed

Figure 18 – Winkeyer2 PB Status Definitions (WK2 Mode)

The PB status byte will be sent whenever the PB state changes, in other words a byte will be sent when a pushbutton is pressed and a byte will be sent when the pushbutton is released. Only one press will be detected at a time.

• **Pointer Cmd <16><nn> Input Buffer Command Set**

This command allows the host app to manipulate the input buffer for special situations such as “on the fly” callsign correction. Four commands make up the pointer command set:

- nn=00 Reset input buffer pointers to start of buffer, only issue this when buffer is empty.
- nn=01 Move input pointer to new position in overwrite mode
- nn=02 Move input pointer to new position in append mode
- nn=03 Add multiple nulls to the buffer <16><03><number of nulls>

A detailed description of the pointer command will be detailed in a separate application note.

- **Set Dit/Dah Ratio** <17><nn> **nn is in the range of 33-66**

Example: <03><42> for ratio=1:4

Modifies the ratio of dit time to dah time, the standard being 1:3 (dit:dah). The formula to determine dah/dit ratio is:

$$\text{DAH/DIT} = 3 * (\text{nn}/50)$$

A value of 50 selects 1:3, a value of 33 would select 1:2, and a value of 66 would select 1:4. This causes an intentional distortion of the Morse waveform. Some ops use this option to make their CW sound less "machine like". *A little goes a long way!!*

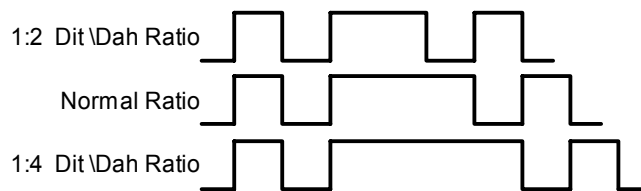

Figure 19 – Three ratio settings for the letter R

Buffered Commands

These commands go into the input buffer maintaining their positional relationship to data.

- **PTT On/Off** <18><nn> **nn = 01 PTT on, n = 00 PTT off**

This command allows the PTT output to be used for a custom purpose. The command is operational only when sidetone and PTT are disabled (See PINCFG command) PTT can be turned on or off at will and will be unaffected by all other commands including Clear Buffer. Typical applications could be as a power level control, antenna selector, or to turn on a cooling fan. Since this is a buffered command, the on/off will happen at the command's position in the buffer and remain in effect until the next PTT ON/OFF command is encountered. This command will not stall the output buffer.

- **Key Buffered** <19><nn> **nn = 0 to 99 seconds**

Use this command to assert the key output for a specific period of time. Since this is a buffered command, the keydown will begin at the command's position in the buffer and will stall the buffer until the timeout has been satisfied. The keydown can be aborted either by the paddles or by a Clear Buffer command. The maximum allowable key down time is 99 seconds.

- **Wait for nn Seconds** <1A><nn> **nn = 0 to 99 seconds**

This command is used to insert a fixed pause into a message. Since this is a buffered command, the pause will begin at the command's position in the buffer and will stall the buffer until the timeout has been satisfied.

- **Merge Letters** <1B>[C][C] **Merge Two Letters into a Prosign**

You can build "on the fly" prosigns with this command. Issue the command followed by two letters or numbers and they will be merged together: <1B>[A][R] is sent as **AR**. Note that nothing will be sent until both letters have been received.

Several common prosigns such as AR, SK, BT, And DN are already assigned (see page 13) so you don't have to build these. One application of this feature is to send special European language characters.

- **Change Speed Buffered** <1C><nn> nn is in the range of 5-99 WPM

Example: <02><23> set 35 WPM

This command places a speed change command into the serial buffer that will be acted upon when it is taken out of the buffer. The current speed in force will be stored and will be reinstated when the buffered speed change is cancelled by a Cancel Speed Change command or any of the following: Unbuffered Speed change, Weight change, Farnsworth change, Ratio change, Compensation change, or Mode change.

This command is useful for building messages with embedded speed changes. In this example the first part of the message will be sent at 5 WPM, the second at 25 WPM and the end at whatever the current speed is:

```
<1C><05>VVV DE K1EL <1C><19> VVV DE K1EL<1E><END DE K1EL>
```

- **HSCW Speed Change** <1D><nn> nn = (lpm/100)

This command acts the same as the immediate HSCW command. This allows you to insert an HSCW burst in a regular CW message or to put HSCW bursts of two different rates into the same message.

- **Cancel Buffered Speed Change** <1E>

This command will cancel any buffered speed change command that is in force. The sending speed that was in force before any buffered speed change was encountered will be restored. Several buffered speed changes can be issued within a message but none will alter the original sending speed.

- **Buffered NOP** <1F>

This command will occupy a position in the input buffer but will result in no action when it is processed.

Unsolicited Status Transmission

Winkeyer2 will send two types of unsolicited status to the host: speed pot change, and a change in status byte. Whenever the speed pot is moved its new value will be sent to the host. Likewise whenever there is a change to the internal status register inside Winkeyer2, a copy of it will be sent to the host. In WK2 mode the WK status byte is expanded to include an alternate status byte that returns pushbutton status.

The status byte will be in the same format as previously described in the Get Status command. Likewise the speed pot status will be as described in the Get Pot command.

Since these bytes can arrive at any time and potentially can be mixed with echo back bytes, they have identifying tags. If the MSB is set that identifies the byte as unsolicited, bit 6 then identifies either a speed pot byte or a status byte. Echo back bytes will always have the MSB=0.

The host can force either of these bytes to be returned by using their respective Get Pot or Get Status commands. Due to the parallel task handling nature of Winkeyer2 a response may not be immediate, there may be a other bytes in the return queue that need to be sent to the host first. Worst case latency will be 200 milliseconds. It is not advisable for the host to wait for a response, it is better to handle it as illustrated by the code fragment shown in an earlier section of this document.

Prosign Key Assignments

Winkeyer2 has mapped several unused character codes to standard prosigns. Table 5 shows the mappings. Any additional prosigns can easily be generated using the merge character command.

ASCII	Hex		Prosign		ASCII	Hex		Prosign
"	0x22	<i>Is mapped to</i>	RR		+	0x2B	<i>Is mapped to</i>	AR
#	0x23	<i>Is mapped to</i>	EE (null)		-	0x2D	<i>Is mapped to</i>	DU
\$	0x24	<i>Is mapped to</i>	SX		/	0x2F	<i>Is mapped to</i>	DN
%	0x25	<i>Is mapped to</i>	EE (null)		:	0x3A	<i>Is mapped to</i>	KN
&	0x26	<i>Is mapped to</i>	EE (null)		;	0x3B	<i>Is mapped to</i>	AA
'	0x27	<i>Is mapped to</i>	WG		<	0x3C	<i>Is mapped to</i>	AR
(0x28	<i>Is mapped to</i>	KN		=	0x3D	<i>Is mapped to</i>	BT
)	0x29	<i>Is mapped to</i>	KK		>	0x3E	<i>Is mapped to</i>	SK
*	0x2A	<i>Is mapped to</i>	EE (null)		@	0x40	<i>Is mapped to</i>	AC

Figure 20 – Prosign/Abbreviations Assignments

Serial Baud Rate

Winkeyer2's baud rate is fixed at 1200 baud. The communications setup should be set to eight bit data, 2 stop bits, and no parity.

Gap Insertion

Winkeyer2 interprets the | character (hex 0x7C) as a ½ dit delay time. The | character can be included in a text string to add extra emphasis to similar sounding sequences. An example is W1OMO, sending it as W1|O|M|O makes it easier to copy.

WK2 Host Mode Command Table

Command Name	Code	Type	Description	Syntax	Pg
Admin	00	Imm	Administrative Commands	<00><type>...	4
Sidetone Freq	01	Imm	Set sidetone frequency	<01><freq>	5
Speed	02	Imm	Set Morse sending speed	<02><WPM>	5
Weighting	03	Imm	Set key weighting	<03><weight>	5
PTT Lead-in/Tail	04	Imm	Set up PTT delays	<04><leadin><tail>	6
Speed Pot Setup	05	Imm	Set up speed pot range	<05><m><wr><pr>	6
Pause	06	Imm	Pause Morse output	<06><0 or 1>	6
Get Speed Pot	07	Imm	Request speed pot value	<07>	7
Backspace	08	Imm	Backup input pointer	<08>	7
Pin Configuration	09	Imm	Set output pin configuration	<09><config>	7
Clear Buffer	0A	Imm	Clear input buffer	<0A>	7
Key Immediate	0B	Imm	Direct control of key output	<0B><0 or 1>	7
HSCW Speed	0C	Imm	Set HSCW speed	<0C><lpm/100>	7
Farnsworth	0D	Imm	Set Farnsworth speed	<0D><WPM>	7
Winkeyer2 Mode	0E	Imm	Load Winkeyer2 mode byte	<0E><mode>	8
Load Defaults	0F	Imm	Download WK state block	<0F><... 15 values...>	9
First Extension	10	Imm	Setup 1 st element correction	<10><msec>	9
Key Compensation	11	Imm	Set Keying Compensation	<11><comp>	9
Paddle Switchpoint	12	Imm	Setup paddle sensitivity	<12><sens>	10
Null	13	Imm	Null Command, NOP	<13>	10
S/W Paddle Input	14	Imm	Software Paddle Control	<14><paddle select>	10
Winkeyer2 Status	15	Imm	Request Winkeyer2 status	<15>	10
Buffer Pointer	16	Imm	Buffer pointer commands	<16><cmd>...	10
Dit/Dah Ratio	17	Imm	Set ratio of dit/dah	<17><ratio>	11
PTT Control	18	Buff	Turn PTT on/off	<18><0 or 1>	11
Timed Key Down	19	Buff	Turn KeyOut on for an interval	<19><secs>	11
Wait	1A	Buff	Wait for N seconds	<1A><secs>	11
Merge Letters	1B	Buff	Merge chars into prosign	<1B><[c][c]>	11
Speed Change	1C	Buff	Change Morse speed	<1C><WPM>	12
HSCW Speed	1D	Buff	Set HSCW speed	<1D><lpm/100>	12
Cancel Buff Speed	1E	Buff	Cancel Buff Speed Change	<1E>	12
Buffered NOP	1F	Buff	Null Command (buffered)	<1F>	12

Figure 21 – WK Host Mode Command Table

Winkeyer2 Standalone Mode

FEATURES

- Keyer speed range: 5 - 99 WPM
- HSCW: 1000, 1500, 2000, 3000, 4000 or 6000 lpm
- QRSS: 3, 6, 10, 12, 30, 60 second dits
- Non-Volatile Message Memory: 232 letters in six slots with embedded commands.
- Dynamically allocated message memory
- Backspace supported on message entry
- Keying Modes: Bug, Ultimatic, Iambic A or B
- Serial Number Generation
- Audio Frequency keying mode (PTT)
- Adjustable Weight 25 to 75 %
- Automatic letterspace mode (Autospace)
- Adjustable Keying Compensation 0 to 31 mSec
- Paddle swap command
- Beacon: Programmable interval: 1 to 99 seconds
- Sidetone Output: TTL Square wave, 100Ω output Z
- Adjustable Sidetone frequency
- Keying/PTT outputs: TTL, high true when keyed
- Speed control potentiometer support
- Push-button user interface
- 22 easy to use commands
- Operating Voltage: 2.5-5.5 VDC, built in oscillator
- Power Consumption: <1 ma active, 1 μA standby
- Downloadable messages

When not connected to a host WK2 will operate in standalone mode. When in standalone mode WK2 closely emulates the K12 keyer IC in functionality. A few enhancements have been added which will be described. The most noticeable difference between host and standalone mode is that when in standalone mode the user can enter commands on the paddles. This is initiated by pressing the command pushbutton. In host mode the pushbuttons are ignored. Low power mode is activated in standalone mode, this means that WK2 will go into a low power sleep state when idle. This makes it very battery friendly.

Push-button Functionality

Winkeyer2 standalone requires at least one push-button control, this switch is referred to as the command push-button and is connected to pin 13. It serves two functions, command control and message record/playback control. Up to five additional message push-buttons can be added to provide a total of six message slots. Be sure to use normally open switches for the push-buttons. Pin 13 is an analog input which senses the switch network shown in Fig 22. Message push-buttons 2 through 6 are connected as shown. Use 5% tolerance resistors for the switching network.

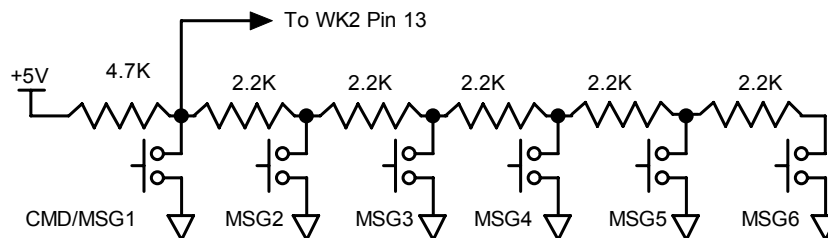

Figure 22 – Pushbutton Matrix

Command Mode

If the command push-button is pressed and held, the WK2 will respond after about two seconds with the letter **R** in sidetone only. This means WK2 is ready to accept a command, you simply enter the command letter in Morse on the paddles and the command will be executed. Some commands require additional information which WK2 will prompt you for by outputting the letter **E** (for enter). All commands provide some sort of feedback to tell you if the command was understood and executed properly. If an illegal command is entered WK2 will respond with a question mark.

Important Note ! When in command mode, transmitter keying is disabled and replies are sent in sidetone only. Thus in order to use command mode you must have a sidetone speaker of some sort. If sidetone had been disabled with the **A** command it will be re-enabled automatically when entering command mode.

WK2 Standalone Command List

A - Select sidetone on or off	O - Select output key port
B - Set Paddle Break mode	Q - Query current settings
C - Set command speed in WPM	R - Review message without transmitting
D - Decrement serial number	S - Set bottom of speed pot range in WPM
F - Set Farnsworth Speed	T - Key transmitter for tuning
G - Select serial number 0/9 format	U - Select Autospacing on/off
H - Set Fast/Slow AFK tail delay	V - Set Keying compensation in mSec
J - Set Paddle sensitivity	W - Set Key Weight
K - Select keyer mode	X - Exchange Paddles
L - Load message memory slot	Y - Set Dit/Dah Ratio
M - Mute Transmit (CPO mode)	Z - Select sidetone frequency
N - Load 4 digit serial number	

In the command descriptions below, the **[n]** or **[nn]** notation means that additional parameters must be entered on the paddles after the command. A letter displayed in **BOLD** is something you enter, **BOLD ITALIC** is what WK2 responds with. A [pb] means that WK2 will wait for you to press one of the message pushbuttons.

A - Sidetone enable is toggled when this command is entered. Toggle means if the sidetone was on when this command was issued it will be turned off and vice versa. WK2 will acknowledge this command by responding with an **R**. Note: If sidetone is disabled it will be re-enabled while in command mode.

B - This command toggles the paddle break state. When enabled (the default), WK2 will allow a paddle press to abort a message, otherwise paddle presses during messages are ignored. This command was included to allow analog telemetry to be taken on the paddle inputs. If you are going to use the analog telemetry feature, disable paddle break so that analog inputs do not cause message abort. When this command is entered WK2 will respond with either a **Y** or **N**. Y means enabled, N means disabled.

C[nn] - This command is used to set the command Morse speed of WK2. WK2 can use different speeds for command and transmit Morse speeds. Changes in transmit speed will not affect command speed. After the **C** command is issued enter the speed in WPM. See the **S** command for details on entering Morse speeds.

D - Decrement serial number by 1, WK2 responds with an **R** after the decrement.

F[nn] - Farnsworth spacing is useful for CW practice because it encourages you to learn characters by sound not individual dits and dahs. In WK2, Farnsworth is implemented by sending letters at a fixed rate of **nn** WPM regardless what the WPM sending rate is. Spacing between characters is determined by the sending rate. When the WPM rate is set above the Farnsworth WPM, Farnsworth is automatically disabled.

G - Toggle serial number format for 0 and 9. WK2 responds **N** for normal, **A** for 0 sent as T and 9 sent as N

H - Sets the transmit PTT hang delay time. You can select one of four delays:

HangTime = 0 Wait 1.0 wordspace before ending paddle insertion
 HangTime = 1 Wait 1.33 wordspace before ending paddle insertion
 HangTime = 2 Wait 1.66 wordspace before ending paddle insertion
 HangTime = 3 Wait 2.0 wordspace before ending paddle insertion

When the H command is entered the hang time will be incremented to the next sequential value, wrapping back to 0 after 3. So to obtain a desired value the H command might have to be entered several times.

J[nn] - This controls when WK2 will start looking for a new paddle press after sensing the current one. If there is not enough delay the keyer will send unwanted dits or dahs, if there is too much delay it bogs you down because you can't get ahead of the keyer. The default value is one dit time (50) and is adjustable in percent of a dit time. Faster operators report a setting somewhat less than default is more pleasing. **If the paddle sensitivity is set to zero, both dit and dah paddle memories are disabled.** The delay is calculated with this formula:

$DELAY_TIME = (nn \times DIT_TIME) / 50$ where switch point is a value between 01 and 99.

K - There are six different keying modes supported by WK2: Iambic mode A and B, Straight Key, Bug, Ultimatic, Dit priority mode, and Dah priority mode. In either iambic mode, alternating dits and dahs are sent

while both paddles are held closed. In mode B an extra alternate dit or dah is sent after both paddles are released. In straight key mode a dah paddle press will key the transmitter for as long as the paddle is pressed. Use the swap command: **X** to choose either the left or right paddle Bug mode directly keys with the dah paddle and generates dits automatically when the dit paddle is pressed. In Ultimatic mode when both paddles are pressed the keyer will send a continuous stream of whichever paddle was last pressed. Dit and dah priority mode will generate dits and dahs automatically in response to single paddle presses, but when both paddles are pressed either dit or dah has priority.

After the **K** command is issued the current mode is set by entering a single letter:

lambic B:	Enter B
lambic A:	Enter A
Ultimatic:	Enter U
Straight Key:	Enter S
Dit Priority:	Enter E
Dah Priority:	Enter T

L [pb] – The **L** command is used to load the message memory slots. There is a detailed description of message loading in the *Message Functionality* section.

M – Toggle transmit muting, useful for off line practice. WK2 responds with **R** for mute on and **N** when mute off.

N [nnnn] – The **N** command is used to load a 4 digit serial number. All four digits must be entered including leading zeroes. The serial number is played by inserting a play message token /N into a message. The serial number is automatically incremented after playing. See *Embedded Command* section for more details.

O – WK2 has two key output ports, 1 and 2. Each time the **O** command is issued the key port is toggled back and forth between 1 and 2. When port 1 is selected a single dit is echoed and two dits are echoed for port 2.

P – This command is used to save the current settings in EEPROM. After the values have been stored WK2 will respond with an **R**. Note that messages are always stored in EEPROM when entered and do not require a **P** command to save them. When changing from host mode back to standalone mode the last settings stored in EEPROM will be restored.

Q - This command is used to query WK2 about its current settings. After the command is issued WK2 will respond with WK2 commands and their settings sent in the following format:

```

WPM is sent first
S followed by Serial Number
F follow by free msg memory space in letter count
C followed by command WPM
W followed by weight
L followed by lead time (see host mode)
T followed by tail time (see host mode)
X followed by 1st extension (see host mode)
K followed by key compensation
F followed by Farnsworth WPM
S followed by Sample Adjust
R followed by dit/dah ratio
M followed by min WPM (see host mode)
G followed by pot range (see host mode)

```

You can stop the response any time after the first parameter is sent by pressing the command pushbutton.

R [pb] - You can review a message without transmitting with this command. After the **R** command is entered WK2 will respond with an **M**. You then press the message button of the message you wish to play. The message will be sent in sidetone only. If you try to play an empty slot WK2 will respond with **MT**. Embedded commands will be sent as is without expansion.

S [nn]- This command is used to move the speed pot's WPM window. Here is the recommended way to use it. First turn the speed pot fully counter clockwise, then enter the S command followed by the desired speed in WPM. That will set the bottom of the speed pot range. The WPM range is 30 WPM so if you set the bottom to 10 WPM the max speed would be 10+30 or 40 WPM. The speed value is entered directly in WPM in the following manner. After the **S** command is issued WK2 will respond with a single **E**, you then directly enter the speed. As a short cut, a **T** can be entered for zero. If the desired speed is a single digit, either enter the single number, or send a zero or T first. i.e. **7** or **07** or **T7** will all give you 7 WPM. Likewise, **2T** can be entered for 20 WPM. If an illegal value is entered, WK2 will respond with a question mark, if the value is good WK2 will respond with an **R**. More details can be found in the Speed Pot Functionality section on Page 21.

T - After a brief pause, this command will key the transmitter for tuning. WK2 will stay in tune mode until the command push-button or paddle is pressed.

U - This command toggles autospace mode. When autospace is enabled WK2 will automatically insert proper inter-letter space between letters. Each time the **U** command is issued WK2 will toggle between modes responding with an **A** for autospace enabled an **N** for autospace disabled.

Here is how autospace works: If you pause for more than one dit time between a dit or dah WK2 will interpret this as a letter-space and will not send the next dit or dah until the letter-space time has been met. The normal letter-space is 3 dit spaces but this can be increased by using the I command. WK2 has a paddle event memory so that you can enter dits or dahs during the inter-letter space and WK2 will send them as they were entered. With a little practice, autospace will help you to send near perfect Morse.

V[nn] – Keying Compensation allows a fixed amount of time to be added to the length of all dits and dahs. QSK keying on modern transceivers can cause shortening of these elements which is especially noticeable at high speeds. WK2 allows the length of the elements to be increased uniformly to compensate for this. The adjustments can be made in one-millisecond steps. The maximum adjustment is 31 mSecs. Key compensation is very similar to Weighting in that any adjustment added to the dits and dahs is subtracted from the spacing so the resulting speed is not changed. The difference between weighting and keying compensation is that compensation is independent of speed, so if 10 mSec of key compensation is selected, 10 mSec will be always be added regardless of speed. So be careful at high speeds with large values of keying compensation, dits and dahs may run together with no spacing at all.

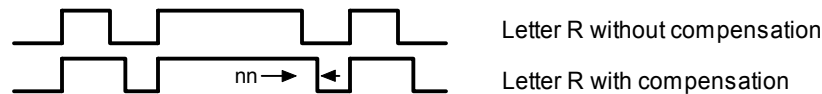

Figure 23 – Key Compensation

W[nn] – The keying weight can be adjusted in percentage from 25% to 75%. When set to 50 % the dit time is equal to the inter-element time, which is normal. Values less than 50 reduce weighting while values greater than 50 increase weighting. Note that weighting does not affect sending speed because any increase in keyed time is subtracted from spacing time. Reduction in weighting results in a thinner sound while increased weighting results in a heavier sound. Since weighting tracks speed, a given weighting will sound the same at all speeds.

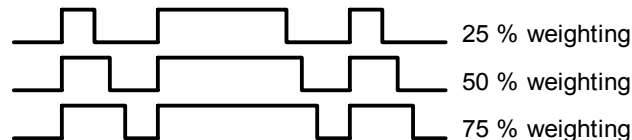

Figure 24 – Key Weighting

X - This command will cause WK2 to exchange paddle Inputs (dit and dah). WK2 will always respond with a letter **R** to signify that this command was accepted.

Y[nn] – Sets the Dit/Dah Ratio, where nn is in the range of 33-66. Entering **Y50** sets the standard 1:3 ratio. The full range is **Y33** for 1:2 up to **Y66** for 1:4 dit/dah ratio.

Z - This command allows the sidetone frequency to be modified. After this command is entered the sidetone oscillator will be turned on. Pressing the paddles will raise or lower the frequency. There are 10 possible choices: 2000, 1333, 1000, 800, 666, 570, 500, 440, and 400 Hz. Pressing the command push-button will end

this command and store the new sidetone frequency. Due to the multi-threaded processing architecture of WK2, continuous sidetone frequency selection is not possible.

Speed Potentiometer Functionality

WK2 uses a potentiometer connected to pin 10 to set sending speed. Turning the pot will change the speed and update the WPM rate after each letter. WK2 does not provide a command to change the WPM range in standalone mode, it is fixed at 30 WPM. The **S** command is used to move the WPM range. Entering a specific speed will move the window so that the current speed pot position will correspond to that WPM. It does this by calculating a new start for the WPM window. For example let's say the pot is set to the half way point and you use the **S** command to enter 25. Since the window is fixed at 30 WPM, the new range would stretch from $25-15=10$ though $25+15=40$. Since the lowest window start point is 5 WPM, if you had entered 10, the start would be $10-15=-5$ an illegal value. WK2 will respond with a **?** and set the window start to 5 WPM. The easiest way to use the **S** command is to turn the pot fully counter clockwise and use the **S** command to set the lowest speed you want the speed pot to cover. The highest speed will then be 30 WPM higher.

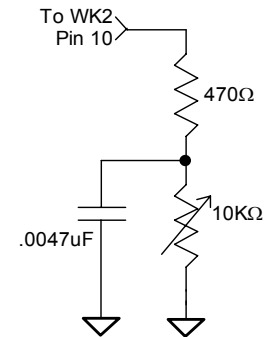

Figure 25

Message Functionality

Messages are loaded using the **L** command. After the command is issued WK2 will respond with an **M** after which the desired message button must be pressed. When WK2 is ready to accept a new message it will respond with an **I**. If you wait too long WK2 will respond with a **?** and you have to start over. Four pushbutton setups are supported this way, after entering the **L** command you can load message 5 by pressing either the dit or dah paddle respectively.

A message is entered directly on the paddles at a steady rate, making sure to leave proper space between letters. To insert a word space simply pause for longer than a word space and WK2 will respond with an **E** to signify a word space insertion. You can also enter a wordspace on the paddles by entering di-di-dah-dah. This allows you to put a wordspace at the beginning of a message. The ½ letterspace pad character by entering di-di-dah-dah-dit.

When the message has been completely entered press the command push-button or enter di-dah-di-dah and WK2 will respond with an **R** to signify that the message was accepted and stored. If a mistake is made while entering a message, press and hold the command push-button and WK2 will backspace through the letters entered. When you reach the position you want, release the button and enter more letters. If the message memory becomes full while entering a message, WK2 will stop further loading, respond with an **F**, and return WK2 back to non-command mode. There are 232 letters in message memory that can be distributed in any way between six message slots. The length of the individual message slots is not fixed. This means, for example, you could have one message of 80 characters, one message with 5 characters, and a third with 10 characters and still have 141 locations left to split among the remaining three slots. Keep in mind that each word space occupies one memory location.

If you are having problems loading messages into WK2, make sure you are leaving adequate space between letters and are not sending much faster or slower than the currently set command speed. If, for example, you enter an **A** followed by a **T** and end up with a **W**, you are not allowing enough space between letters. It's a fine line though because if you allow too much space WK2 will interpret that as a word space. Lowering the command speed can help.

To play a message back, simply press the desired message button and the message will be sent. If you want to review the message without keying the transmitter, use the **R** (review) command. Review will play the pad character as di-di-dah-dah-dit. To abort a message, press the CMD PB or press and hold one of the paddles and WK2 will stop transmission after the current letter is completed and will respond with an **E** in a lower frequency sidetone.

There is a short cut for message loading. After pressing the command button, wait for WK2 to send an **R**, release the command button and then press the desired message button. WK2 will respond with an **I** and you can

directly enter a message without entering the **M** command. Don't forget that the command pushbutton is also a message button.

Commands can be embedded in a message. The format is the *slash* character **DN** (D and N sent together as one letter) followed by the desired command letter. If you want to insert the DN prosign into a message but don't want it to be interpreted as a command simply enter DN twice. Example: K1EL/1 would be entered as K1EL//1

Embedded command table

/Bnn	Set a beacon cycle time of nn seconds (nn=00 to 99). Put this at the beginning of a message to set the beacon period.
/Cn	Call message and then return
/D	Decrement serial number.
/Hn	Set HSCW speed. See table below for determining n.
/Knn	Key transmitter for nn seconds (nn=00 to 99)
/N	Play Serial Number with auto increment.
/P	Pause and wait for paddle entry and then continue after one word space time. The pause is ended three ways 1) paddle entry 2) Press a msg PB (2-6) or 3) Press the cmd PB to cancel.
/Qn	Set QRSS speed. See table below for determining n
/Snn	Set a new sending speed (nn=WPM, 5 to 59)
/Wnn	Wait for nn seconds (nn=00 to 99)
/X	Cancel /S, /H, or /Q command
/Y	Analog Sample pin 11
/Z	Analog Sample pin 12
/1	Jump to message 1
/2	Jump to message 2
/3	Jump to message 3
/4	Jump to message 4
/5	Jump to message 5
/6	Jump to message 6

Rate Table for /Hn or /Qn commands

n	HSCW Rate	QRSS Rate
0	1000 lpm (200 wpm)	3 sec dit
1	1500 lpm (300 wpm)	6 sec dit
2	2000 lpm (400 wpm)	10 sec dit
3	3000 lpm (600 wpm)	12 sec dit
4	4000 lpm (800 wpm)	30 sec dit
5	6000 lpm (1200 wpm)	60 sec dit

Figure 26 – HSCW/QRSS Command Table

Command Examples

/B60BCON DE K1EL BEDFORD NH/1 will send this beacon message in slot 1 every 60 seconds
BCON DE K1EL/W60/4 will send this message in slot 4, wait 60 secs and then repeat it
UR RST IS /P QSL will pause to allow the user to enter the RST then resume automatically
/K05 K1EL BCON/W10/1 will key down for 5 secs, send the message, wait 10 seconds and then repeat
CQ CQ CQ DE /1 will send the call loaded in message slot 1
/H2CQ CQ DE K1EL K1EL K1EL/S15DE K1EL will send 1st part at 2000 lpm and the 2nd at 15 WPM
CQ CQ CQ DE K1<di-di-dah-dah-dit>ISI will send message with extra space between ISI for clarity
/Q1EL /1 will continuously send EL at QRS3 speed
 Try to avoid inserting a space between a QRSS command and the start of text since this will cause a long delay before anything is sent.

Analog Sample Command

This buffered command allows WK2 to send telemetry. Embedding either the **/Y** or **/Z** commands will tell WK2 to read the specified pin's resistance and send it as a number in Morse. The pins are the paddle inputs, so the way it works is that you enter the message and when ready, swap the paddles for resistive sensors and start a message with a button press. Most often, the message will be sent as a beacon. The values sent are determined

by a voltage divider where the top of the divider is a 4.7K resistor and the bottom resistor is the sensor. The formula for the value sent is $(\text{sensor resistance}/4700)*255$. So if the sensor has a resistance of 1K then $(1000/4700)*255 = 54$.

QRSS/HSCW Operation

The /H and /Q buffered commands allow HSCW or QRSS strings to be sent in standalone mode. Note that only HSCW strings can be sent in host mode. HSCW strings can be aborted with either a paddle press or a command pushbutton press. QRSS strings can be aborted with a command pushbutton press only. Upon abort normal keying speed is resumed.

Reset WK2/Restore Factory Defaults

As mentioned previously, the command pushbutton can restore Winkeyer2 operation if a lockup has occurred. Lockup can happen if Winkeyer2 is disconnected from the host unexpectedly while the host is actively communicating to Winkeyer2. It's very unlikely a lockup will occur but it can happen so a means is provided to recover.

Normally, you press the command button and wait for an **R** before entering a command. If you continue to press the command button after the **R** is sent, after about five seconds, WK2 will send 6 dits in sidetone and then reboot back to standalone mode and reload the standalone settings. You can then replug it back into the PC and reopen it from you app or just use it in standalone mode. Note that the standalone message contents are not erased and all other settings will be restored back to the standalone settings you had preserved.

If you have a case where you just want to return WK2 back to factory defaults, a special command sequence is provided. Press the command button, wait for the **R** and then enter di-dah-di-dah. When WK2 responds with an **R**, re-enter di-dah-di-dah and WK2 will clear all settings including messages and return to factory defaults. After the initialization is complete WK2 will send dah-dah-dah-dit.

Sleep Mode

WK2 utilizes the low power sleep mode of the PIC CPU. WK2 normally rests in sleep mode and draws about 1 μA of DC current. When either of the paddles or a push-button is pressed, the chip wakes up and goes into active mode drawing less than 1 ma idle and about 10ma while actively sending driving sidetone. After the paddle or push-button is serviced WK2 goes back to sleep after a few seconds.

Keyer Lock

A lock feature is provided to disable the paddle input and message pushbuttons. This is useful when you want to pack up the keyer and want to effectively turn it off. Other times it's nice to lock the keyer paddles to keep little hands from sending "messages" While the keyer is locked it is kept in low power shutdown mode. To lock the keyer press the command pushbutton, wait for the R and then enter a period (di-dah-di-dah-di-dah). To unlock the keyer press and hold the command pushbutton for about 5 seconds and WK2 will wake up and send an R.

WK2 Standalone Tutorial

On 1st time power up, or on restore defaults command, WK2 will be reset to factory defaults which are:

Operating WPM:15	Command WPM:15	Sidetone:2KHz	Weight:50%
KeyComp:0		SampleAdjust:50%	KeyMode:lambic B
Sidetone:On	Autospace:Off	Key/PTT: Port 1	Serial Number:0001

Press the paddle keys and WK2 will generate dits and dahs both in sidetone and keyed output. Let's enter a simple command to swap the paddles. Press the command pushbutton (CMD PB) until WK2 answers with an **R**. Then, without hesitation, enter an **X** on the paddles. WK2 will answer with an **R** letting you know the command succeeded. If it did not understand the command or you are too late to enter a command, WK2 will respond with a question mark. To swap the paddles back enter the **X** command again. Next, let's change the command entry speed. You'll enter the **C** command followed by the desired speed, let's try 10 WPM. Press the CMD PB, wait for the **R**, and then enter **C**. WK2 will respond with an **E** telling you it's waiting for you to enter something. You then enter a 1 followed by a 0. Try it again but this time use a T for the zero. This is a handy shortcut. The operating speed is set in a similar manner using the **S** (speed pot window) command. See page 19.

Next we'll change the keying mode. Enter the **K** command followed by a letter signifying the mode you want (see page 18). **K B** will set lambic mode B, **K A** will set lambic mode A, **K U** sets Ultimatic. Give each mode a try to get familiar with how they work. The sample adjust command will allow you to tweak the paddle sensitivity to home in on the way you want the paddles to respond. Setting sample adjust to zero will disable the dit and dah paddle memories. You can save your settings in internal EEPROM at any time by pressing the CMD PB until WK2 responds with an **R** then entering a **P**.

The Weight, Keying Compensation, and Dit/Dah Ratio commands adjust the way Morse is generated. Read the command descriptions carefully to understand how they work. The sidetone frequency is adjusted by using the **Z** command. Press the paddles to adjust the sidetone frequency, hit CMD PB when done. Due to the response of the small speaker you'll find that the higher frequencies are the loudest.

Now enter some messages. Review the procedure for message loading on page 18. WK2 has two great features associated with messages. The first is backspace, if you make a mistake while entering a message just backspace to fix the error. The second is the size of the message slots is not fixed, if you only use two bytes in slot one, only two bytes of message memory are used up, not an entire slot. Once you have mastered message loading you can tackle some embedded commands. An easy one to start with is a speed change command. In slot one enter: **/S10SLOW /S25FAST**. This message will play at two different speeds. Note that after playing this message the operating speed will be returned to the original speed. We can compose a beacon command easily: In msg slot 2 enter: **/B60/K05 BCON DE K1EL NH/2** It will keydown for 5 seconds, send BCON DE K1EL NH and repeat this every 60 seconds. To cancel a beacon, press the CMD PB or the paddle, WK2 will stop the loop and respond with an **I** to let you know something was cancelled.

Serial numbering is easy to use. First enter a starting serial number with the PB CMD **N**. You need to enter all four digits including leading zeroes. Next select the way you want WK2 to send 0s and 9s in a serial number. Use the CMD PB **G** command for this. To compose a message that will play a serial number, enter: **CQ DE K1EL/P UR NR/N QSL?/P** in slot 3. This message will send CQ and then pause to let you listen for a reply. If no reply, hit msg PB 3 to repeat the CQ. If there was a reply enter the station's callsign and WK2 will send the serial number and pause again. If the station needs a repeat of the callsign press 2 to play this message in slot 2: **UR NR /D/N QSL ?** Since the serial number is incremented after an /N command you need to pre-decrement it to send the original number. The /P command is a three-way branch, 1st branch: paddle something to continue, 2nd branch: hit a msg button (other than CMD PB), 3rd branch: hit the CMD PB to cancel the message. Since MSG1 = CMD PB you can't use slot one as a 2nd branch choice.

WK2 supports two alternate sending rate modes. They are selected by putting embedded commands in the message. QRSS is extremely slow CW for VLF work, and HSCW is extremely fast CW typically used for QSOs via meteor scatter. Here are examples of each:

QRSS: **/K10/ Q2EL/2** Keydown for 10 seconds followed by EL at QRSS6 rate, will repeat in slot 2
HSCW: **/H3K1EL K1EL K1EL K1EL K1EL K1EL /1** Callsign in slot 1 is repeated at 3000 lpm

You can toggle output port by using the O command. This allows you to key one of two radios from the same keyer.

Index	
Introduction	1
Features	1
Theory of Operation	2
Paddle Input Priority	3
Standalone Keyer Mode	3
Power Up Default State	4
Winkey Lockup Recovery	4
Pushbutton Notification	4
USB Sense	4
Host Mode Command Descriptions	5
Immediate Commands	5
Immediate Admin Commands	5
• Admin <00><nn> nn is a value from 0 to 8	5
• Sidetone Control <01><nn> nn is a value determined from Table 1 & 2	6
• Set WPM Speed <02><nn> nn is in the range of 5-99 WPM	6
• Set Weighting <03><nn> nn is in the range of 10-90%	6
• Set PTT Lead/Tail <04><nn1><nn2> nn1 sets lead in time, nn2 sets tail time	7
• Setup Speed Pot <05><nn1><nn2><nn3> nn1 = MIN, nn2 = RANGE, nn3 = don't care	7
• Set Pause State <06><nn> nn = 01 pause, value = 00 unpause	7
• Get Speed Pot <07> no parameter	7
• Backspace <08> no parameters	8
• Set PinConfig <09><nn> low nibble determines how output pins are mapped	8
• Clear Buffer <0A> no parameters	9
• Key Immediate <0B><nn> nn = 01 keydown, n = 00 keyup	9
• Set HSCW <0C><nn> nn = the lpm rate divided by 100	9
• Set Farns WPM <0D><nn> nn is in the range of 10-99	9
• Set Winkeyer2 Mode <0E><nn> nn = Mode bit field in binary	9
• Load Defaults <0F><value list> value list is a set of 15 binary values	10
• Set 1 st Extension <10><nn> nn is in the range of (0 to 250) × 1 mSecs	10
• Set Key Comp <11><nn> nn is in the range of (0 to 250) × 1 mSecs	11
• Request Winkeyer2 Status <15> no parameter, Return Winkeyer2's status byte	12
• Pointer Cmd <16><nn> Input Buffer Command Set	12
• Set Dit/Dah Ratio <17><nn> nn is in the range of 33-66	13
Buffered Commands	13
• PTT On/Off <18><nn> nn = 01 PTT on, n = 00 PTT off	13
• Key Buffered <19><nn> nn = 0 to 99 seconds	13
• Wait for nn Seconds <1A><nn> nn = 0 to 99 seconds	13
• Merge Letters <1B>[C][C] Merge Two Letters into a Prosign	13
• Change Speed Buffered <1C><nn> nn is in the range of 5-99 WPM	14

• HSCW Speed Change <1D><nn> nn = (lpm/100)	14
• Cancel Buffered Speed Change <1E>	14
• Buffered NOP <1F>	14
Unsolicited Status Transmission	15
Prosign Key Assignments	15
Serial Baud Rate	15
Gap Insertion	15
WK2 Host Mode Command Table	16
Winkeyer2 Standalone Mode	17
Push-button Functionality	17
Command Mode	17
Speed Potentiometer Functionality	21
Message Functionality	21
Embedded command table	22
Command Examples	22
Reset WK2/Restore Factory Defaults	23
Sleep Mode	23
Keyer Lock	23
Change History:	27
Contact Information	27

Change History:

1.16.2006 ste First version
3.31.2006 ste Updates, still a draft

Contact Information

Winkeyer2 is fully guaranteed and if you are not satisfied please return the chip or kit for a full refund.

Please post questions on the K1EL Message Board:

http://groups.yahoo.com/group/k1el_keyers/

You can contact K1EL directly at:

Steven T. Elliott K1EL
43 Meadowcrest Drive
Bedford, NH 03110 USA

e-mail: K1EL@k1el.com

website: www.k1el.com

WK2 Standalone Command List

A - Select sidetone on or off	O - Select output key port
C - Set command speed in WPM	Q - Query current settings
D - Decrement serial number	R - Review message without transmitting
F - Set Farnsworth Speed	S - Set bottom of speed pot range in WPM
G - Select serial number 0/9 format	T - Key transmitter for tuning
H - Set Fast/Slow AFK tail delay	U - Select Autospacing on/off
J - Set Paddle sensitivity	V - Set Keying compensation in mSec
K - Select keyer mode	W - Set Key Weight
L - Load message memory slot	X - Exchange Paddles
M - Mute Transmit (CPO mode)	Y - Set Dit/Dah Ratio
N - Load 4 digit serial number	Z - Select sidetone frequency

Embedded command table

/Bnn	Set a beacon cycle time of nn seconds (nn=00 to 99). Put this at the beginning of a message to set the beacon period.
/Cn	Call message and then return
/D	Decrement serial number.
/Hn	Set HSCW speed. See table below for determining n.
/Knn	Key transmitter for nn seconds (nn=00 to 99)
/N	Play Serial Number with auto increment.
/P	Pause and wait for paddle entry and then continue after one word space time. The pause is ended three ways 1) paddle entry 2) Press a msg PB (2-6) or 3) Press the cmd PB to cancel.
/Qn	Set QRSS speed. See table below for determining n
/Snn	Set a new sending speed (nn=WPM, 5 to 59)
/Wnn	Wait for nn seconds (nn=00 to 99)
/X	Cancel /S, /H, or /Q command
/Y	Analog Sample pin 11
/Z	Analog Sample pin 12
/1	Jump to message 1
/2	Jump to message 2
/3	Jump to message 3
/4	Jump to message 4
/5	Jump to message 5
/6	Jump to message 6

Rate Table for /Hn or /Qn commands

n	HSCW Rate	QRSS Rate
0	1000 lpm (200 wpm)	3 sec dit
1	1500 lpm (300 wpm)	6 sec dit
2	2000 lpm (400 wpm)	10 sec dit
3	3000 lpm (600 wpm)	12 sec dit
4	4000 lpm (800 wpm)	30 sec dit
5	6000 lpm (1200 wpm)	60 sec dit